

W-2  
June -23

**PROCUREMENT OF WORKS UNDER  
LOCAL COMPETITIVE BIDDING**

**CONSTRUCTION OF GODOWN 2000 MT  
For**

**BHUMIPSARSH FARMER PRODUCER COMPANY LTD. JAMB  
TA. MOHADI DIST. BHANDARA**

**UNDER**

**Hon. Balasaheb Thackeray Agribusiness Rural Transformation  
(SMART) Project**

**(Two -Envelope Bidding Process without e-Procurement)**

**TENDER NOTICE**

**Hon. Balasaheb Thackeray Agri-business & Rural Transformation Project (SMART)**

Govt. of Maharashtra is implementing World Bank assisted Hon. Balasaheb Thackeray Agribusiness And Rural Transformation (SMART) Project for developing Agriculture Commodity value chains. Bhumisparsha farmer Producer Company Ltd. Jamb Ta, Mohadi Dist. Bhandara is one of the beneficiaries under the project and inviting bids for the following works.

Name of work (Components)	Estimated Tender Amount in Rs.	Tender fee Rs.	EMD	Period of Completion
CONSTRUCTION OF GODOWN 2000 MT	Rs. 180.00 Lakh	Rs. 1000 +180 (GST 18%) = <b>1180/-</b>	Submission of bid security declaration	08 Months
Sale of tender document		From 29/06/2023 To 28/07/2023 up to 5PM		
Date & Time of Pre-bid meeting		13/07/2023 at 11.00 AM		
Tender Submission end date & time		28/07 /2023 up to 5.00 PM		
Technical bid opening date & time		29/07/2023 at 11.00 AM		

Bid document is available at the following office address and also on project website <https://www.smart-mh.org>. For further any updates / notices shall be published on project website only.

-Sd -

**President**

**Kiran Haribhau Atkari**

Bhumisparsh farmer Producer Company Ltd.

Jamb Ta. - Mohadi Dist. - Bhandara

Mob. No. 9518581973 Email-kiranatkari74@gmail.com

REQUEST FOR BIDS (RFB)  
**(Two -Envelope Bidding Process without e-Procurement)**

**LOCAL OPEN COMPETITIVE BIDDING**

Date: 28/06/2023

LCB No.: SMART/bhumisparsh FPC/Works/10/2023

1. Govt. of Maharashtra is implementing World Bank assisted Hon. Balasaheb Thackeray Agribusiness And Rural Transformation (SMART) Project for developing Agriculture Commodity value chains. Project is extending up to 60% grants in the form of Viability Gap Fund (VGF) to eligible Community Based Organizations (CBO).
2. The SMART Project is being implemented by various Project Implementation Units. PIU Agriculture is one of the implementing unit of SMART Project. Bhumisparsh farmer Producer Company Ltd. Jamb Ta. - Mohadi Dist. - Bhandara is one of the beneficiary of PIU Agriculture under the SMART project.
3. The Bhumisparsh farmer Producer Company Ltd. Jamb Ta. - Mohadi Dist. - Bhandara intends to apply a part of the funds to cover eligible payments under the contracts for which this tender has been invited. Bidding is open to all bidders from eligible source countries as defined in the "Procurement Regulations for IPF Borrowers, July 2016, Revised August 2018 and November 2020". Bidders should be registered civil contractor with any of the Government organization with appropriate class. **Bidders are advised to note the minimum qualification criteria specified in Clause 2 of the Instructions to Bidders to participate in the bidding process.** In addition, please refer to paragraphs 3.14 and 3.15 of the "Procurement Regulations" setting forth the World Bank's policy on conflict of interest.
4. Bhumisparsh farmer Producer Company Ltd. Jamb Ta. - Mohadi Dist. - Bhandara (herein after called "Employer") invites sealed bids for construction of works detailed in the table below. The bidders should submit bid for all the works indicated therein.
5. Bidding document may be purchased from the Employer's office by paying non-refundable fee as indicated in the tender notice in the form of cash or Demand Draft issued by any Scheduled/Nationalized bank. Bidder may also download bidding document from <https://www.smart-mh.org> website and submit bid document cost in the form of demand draft along with the bid. Interested bidders may obtain further information from the Employer office.  
*Note: The above-mentioned website is for the purpose of downloading the tender document only. Interested bidders are requested to contact above mentioned address for further information*
6. Bids must be accompanied by a bid security in the form of bid security declaration in the format provided with this tender document.
7. Bids must be delivered to Employer office on or before period mentioned in the tender /corrigendum notice and will be publicly opened on date and time mentioned in the tender /corrigendum notice in presence of the bidders who wish to attend.
8. If the office happens to be closed on the date of receipt of the bids as specified, the bids will be received and opened on the next working day at the same time and venue. Late Bids will be rejected.
9. Other details can be seen in the bidding document.

## Instructions to Bidders

### SECTION - A

#### 1) Scope of Works:

The Employer invites bids for the construction of works as detailed in the table given below

Sr. No.	Name of work	Approximate value of work in Rs.	Period of completion
1	CONSTRUCTION OF GODOWN 2000 MT	180.00 Lakhs	08 Months

The successful bidder will be expected to complete the works by the intended completion date specified above.

#### 2) Qualification criteria of bidder:

The bidder should fulfill following all qualification criteria: -

- a) Should have GST registration
- b) Should possess valid license for executing civil works as per appropriate class issued by central or state PWD or any government department.
- c) should have achieved in at least one year an annual financial turnover of value not less than **Rs. 180.00 lakhs** in the last five years i.e., during FY 2017-18 to 2021-22 OR FY 2018-19 to 2022-23;
- d) Experience of having successfully completed similar works during last 5 years ending last day of month previous to the one in which bid is invited
  1. Three similar completed works each costing not less than the amount equal to **Rs. 72.00 lakhs** OR
  2. Two similar completed works each costing not less than the amount equal to **Rs. 90.00 lakhs** OR
  3. One similar completed work costing not less than the amount equal to **Rs.144.00 lakhs**
- e) Should have availability of liquid assets and/or credit facilities, net of other contractual commitments and exclusive of any advance payments which may be made under the Contract or solvency of not less than **Rs. 45.00 lakhs**.
- f) Should not have been black listed, debarred or suspended on the date of bid opening by any of the Government organization, the World Bank Group.
- g) should possess valid electrical license for executing building electrification works (in the event of the works being sub-contracted, the sub-contractor should have the necessary license);
- h) No contract should have been suspended or terminated and/or performance security called by an employer(s) for reasons related to Environmental, Social (including sexual exploitation and abuse (SEA) and gender-based violence (GBV)), Health, or Safety (ESHS) requirements or safeguards in the past five years.
- i) Should not have Conflict of Interest as mentioned in the ITB 3.

#### 3) Conflict of Interest:

Any Bidder found to have a conflict of interest shall be disqualified. A Bidder may be considered to have a conflict of interest for the purpose of this bidding process, if the Bidder:

- a) directly or indirectly controls, is controlled by or is under common control with another Bidder; or
  - b) receives or has received any direct or indirect subsidy from another Bidder; or
  - c) has the same legal representative as another Bidder; or
  - d) has a relationship with another Bidder, directly or through common third parties, that puts it in a position to influence the bid of another Bidder, or influence the decisions of the Employer regarding this bidding process; or
  - e) any of its affiliates has been hired (or is proposed to be hired) by the Employer or Borrower as Engineer for the Contract implementation;
  - f) has a close business or family relationship with the concerned professional staff of the Borrower or of the project implementing agency.
- (\*for further details refer to paragraphs 3.14 and 3.15 of the “Procurement Regulations” setting forth the World Bank’s policy on conflict of interest)

**4) Bid Price**

- a) The contract shall be for the whole works as described in drawings and technical specifications. Corrections, if any, shall be made by crossing out, initialing, dating, and rewriting.
- b) The rate/price should be inclusive of all duties, GST, other levies payable by the contractor under the contract.
- c) The rates quoted by the bidder shall be fixed for the duration of the contract and shall not be subject to adjustment on any account.
- d) The bidder shall fill in the prices for the Works in conformity with the bidding documents, both in figures and words.
- e) Bidder need to quote for all the items mentioned in the BOQ. If bidder failed to quote for any or more items given in the BOQ and if bidder is selected, in such case bidder has to complete the work of the said item/items without any cost.

**5) The set of bidding document comprise of the following:**

- a) Layout Drawings of the works;
- b) Structural Details
- c) Bill of Quantities;
- d) Technical Specifications;
- e) Instructions to Bidders; and
- f) Draft Contract Agreement format which will be used for finalizing the agreement for this Contract.
- g) Structural Design

**6) Tender Fee & Bid Security:**

**a) Tender Fee:**

Bidding document should be purchased from the Employer office for a non-refundable fee as indicated. Bidder may also download bid document from aforesaid website and submit bid document cost in the form of demand draft along with the bid. If bidder fails to submit the tender fee, the bid submitted by such bidder shall be rejected.

**b) Bid Security:**

- 1) Bidder should submit bid security declaration in the attached format. If bidder not submitted bid security declaration, the bid submitted by such bidder shall be rejected.
- 2) The Bid Security declaration shall be executed
  - a) if a bidder withdraws its bid prior to the expiry date of bid validity specified by the bidder on the letter of bid or any extended date provided by the bidder; or
  - b) During the bid process, if any information submitted found manipulated / hidden /false / mala fide in the bid
  - c) if the successful Bidder fails to
    - (i) sign the Contract or
    - (ii) furnish a Performance Security

**7) Cost of Bidding:**

The Bidder shall bear all costs associated with the preparation and submission of its Bid, and the Employer shall not be responsible or liable for those costs, regardless of the conduct or outcome of the Bidding process.

**8) Language of Bid:**

The Bid, as well as all correspondence and documents relating to the Bid exchanged by the Bidder and the Employer, shall be written in the English language.

**9) Pre-bid Meeting:**

The pre-bid meeting will be conducted by purchaser for the interested bidders. Bidders are requested to attend a pre-bid meeting for clarification on the any terms and conditions, technical specifications etc. on the time, date, and place mentioned therein. Participation in such a pre-bid meeting is not mandatory. If a bidder does not participate or submit any query, then no subsequent representations from them regarding the technical/ commercial specifications/other conditions shall be entertained.

**10) Amendment of Bidding Document**

- a) At any time prior to the deadline for submission of Bids, the Employer may amend the bidding document by issuing addenda.
- b) Any addendum issued shall be part of the bidding document and shall be communicated in writing to all who have obtained the bidding document from the Employer. The Employer will also promptly publish the addendum on the Employer's website.
- c) To give prospective Bidders reasonable time in which to take an addendum into account in preparing their Bids, the Employer may, at its discretion, extend the deadline for the submission of Bids.

**11) Bid Validity Period:**

Bid shall remain valid for a period not less than 120 days after the deadline date specified for submission of bid.

**12) Submission of Bids:**

- a) The bidder is advised to visit the site at his own expense and obtain all information that may be necessary for preparing the bid.
- b) Each bidder shall submit only one bid.
- c) Modification and Withdrawal of Bids – Resubmission of bid by the bidders for any number of times before the final date and time of submission is allowed.
- d) Bid shall comprise of the following 2 envelopes:
  - 1) **Envelope 1:** Technical bid

2) **Envelope 2:** Financial /price bid

**Note: The above both the envelopes are to be submitted in a separate sealed envelopes mentioning the Technical bid and financial bid on top of the each envelop and bidders name at bottom of the envelope. Both these two envelopes shall be packed in a one outer envelope & seal it.**

The sealed outer envelope will also bear the following identification: -

- Bid for - CONSTRUCTION OF GODOWN 2000 MT
- Bidder's name.....
- Bidder's address .....
- Bidder's contact number .....

**1) Technical bid: (Envelop 1)**

The bidder shall submit following documents in the technical envelope.

- 1) Demand draft towards tender document fee if tender document downloaded from the website OR payment receipt if tender document purchased from the employer office.
- 2) Details of technical documents submitted (form no 1)
- 3) Qualification information in the format (Form -2)
- 4) Bid security declaration (Form-3)
- 5) The declaration that the bidder is not black listed/banned by any Government department / Public Sector Undertaking/ Private Sector/ or any other agency (form no 4)
- 6) Declaration about not have Conflict of Interest as mentioned in the ITB 3. (Form No 5)
- 7) Turn over certificate issued by the Chartered Accountant (Form-6)
- 8) Evidence of access to or availability of cash flow issued by any financial institution (Format 7A) or Solvency certificate issued by the Bank, CA or Govt Dept (form 7/B or 7/C).
- 9) Contractor registration certificate of appropriate class issued by the any Government organization.
- 10) GST registration certificate
- 11) valid electrical license for executing building electrification works (self or sub-contractor)

**2) Financial Bid: (Envelop 2)**

The bidder shall quote for all items given in the attached quotation format only (Form no 8 & 9).

**13) Deadline for Submission of Bids:**

- a) Bids must be received by the Employer at the address and no later than the last date and time for submission of bid.
- b) The Employer may, at its discretion, extend the deadline for the submission of Bids by amending the bidding document in accordance with ITB 10, in which case all rights and obligations of the Employer and Bidders previously subject to the deadline shall thereafter be subject to the deadline as extended.

**14) Late Bids**

The Employer shall not consider any bid that arrives after the deadline for submission of Bids. Any Bid received by the Employer after the deadline for submission of Bids shall be declared late, rejected, and returned unopened to the Bidder.

#### **15) Bid Opening and Evaluation of bids:**

##### **a) Opening of Envelop - A (Technical Bid)**

The 'Technical Envelop' of bids will be publicly opened first in the presence procurement committee members and bidders' designated representatives and anyone who chooses to attend at the address on the date and time specified in the tender notice. In the event of the date specified for bid opening being declared as a closed holiday for the Employer's office, the due date for opening of bids will be the following working day at the same time and venue.

##### **b) Evaluation of Technical Bid**

The evaluation of the technical bids will be carried out as per the eligibility criteria mentioned in the clause 2. The bidders fulfilling minimum eligibility criteria are declared technically qualified and eligible opening of the financial proposal.

##### **c) Opening of Envelop - 2 (Financial Bid)**

Financial envelope of technically qualified bidders shall be opened in the presence employer' and bidders' representatives on the date and time informed by the Employer.

#### **16) Confidentiality:**

- a) Information relating to the evaluation of bids and recommendation of contract award, shall not be disclosed to bidders or any other persons not officially concerned with the bidding process until the information on Intention to Award the Contract is transmitted to all bidders.
- b) Any effort by a bidder to influence the Employer in the evaluation or contract award decisions may result in the rejection of its bid.
- c) During the time of bid opening to the time of Contract Award, if any bidder wishes to contact the Employer on any matter related to the bidding process, it should do so in writing.

#### **17) Clarification of Bids:**

- a) To assist in the examination, evaluation, comparison of the bids, and qualification of the bidders, the Employer may, at its discretion, ask any bidder for a clarification of its bid. Any clarification submitted by a bidder in respect to its bid and that is not in response to a request by the Employer shall not be considered. The Employer's request for clarification and the response shall be in writing. No change, including any voluntary increase or decrease, in the prices or substance of the bid shall be sought, offered, or permitted, except to confirm the correction of arithmetic errors discovered by the Employer in the Evaluation of the Bids.
- b) If a Bidder does not provide clarifications of its Bid by the date and time set in the Employer's request for clarification, its Bid may be rejected.

#### **18) Nonconformities, Errors and Omissions**

- a) A bid is substantially responsive; the Employer may waive any nonconformity in the bid.

- b) A bid is substantially responsive; the Employer may request that the bidder submit the necessary information or documentation, within a reasonable period of time, to rectify nonmaterial nonconformities or omissions in the bid related to documentation requirements. Such omission shall not be related to any aspect of the price of the bid. Failure of the bidder to comply with the request may result in the rejection of its bid.

### **19) Correction of Arithmetical Errors**

1. If the bid is substantially responsive, the Employer shall correct arithmetical errors on the following basis:
  - (a) if there is a discrepancy between the unit price and the line item total that is obtained by multiplying the unit price by the quantity, the unit price shall prevail and the line item total shall be corrected, unless in the opinion of the Employer there is an obvious misplacement of the decimal point in the unit price, in which case the line item total as quoted shall govern and the unit price shall be corrected;
  - (b) if there is an error in a total corresponding to the addition or subtraction of subtotals, the subtotals shall prevail and the total shall be corrected; and
  - (c) if there is a discrepancy between words and figures, the amount in words shall prevail, unless the amount expressed in words is related to an arithmetic error, in which case the amount in figures shall prevail subject to (a) and (b) above.
2. Bidders shall be requested to accept correction of arithmetical errors. Failure to accept the correction shall result in the rejection of the Bid.

### **20) Evaluation of financial bids**

To evaluate a bid, the Employer shall consider the following:

- a) Financial evaluation will be done for all items together
  - b) Price adjustment for correction of arithmetic errors in accordance with ITB 19.
  - c) By applying the above evaluation criteria, the Employer shall determine the Most Advantageous Bid. This is the bid of the bidder that meets the qualification criteria and whose bid has been determined to be:
    - (a) Substantially responsive to the bidding document; and
    - (b) the lowest evaluated cost.
- 21)** Information relating to evaluation of bids and recommendations for the award of contract shall not be disclosed to bidders or any other persons not officially concerned with the process until the award to the successful bidder is announced.

### **22) Award of contract**

- a) The Employer will award the contract to the successful bidder whose bid has been determined to be the Most Advantageous Bid i.e. the bid that meets the specified Qualification Criteria and has been determined to be (a) substantially responsive to the bidding document; and (b) the lowest evaluated cost.
- b) Notwithstanding the above, the Employer reserves the right to accept or reject any Bid and to cancel the bidding process and reject all Bids at any time prior to the award of contract.

- c) The successful bidder will be notified of the award of contract by the Employer prior to expiration of the bid validity period.
- d) The Bid security of unsuccessful bidders will be returned as promptly as possible upon the successful Bidder's signing the contract and furnishing the performance security.  
Note: In case of a tie of evaluated cost between two or more bidders, discount shall be taken from all the L1 bidders. In case there is still a tie, bidder with the maximum turnover shall be awarded contract

**23) Performance Security**

Within 15 days of receiving letter of acceptance, the successful bidder shall deliver to the Employer the performance security (either a bank guarantee or a bank draft in favour of the Employer) for an amount equivalent of 3% of the contract price. The Performance Security shall be valid until a date 28 days after the date of issue of the Certificate of Completion. Failure of the successful Bidder to furnish performance security and sign the agreement within the period stipulated shall constitute sufficient grounds for annulment of award and forfeiture of the Bid Security, in which case the Employer may make the award to the Bidder offering the next Most Advantageous Bid who ready to match L1 rate or issue a new LCB.

**24) Defects Liability:**

The "Defects Liability Period" for the work is Twelve months from the date of taking over possession or one full monsoon season whichever occurs later. During this period, the contractor will be responsible for rectifying any defects in construction free of cost to the Employer.

- 25) Supply of all construction materials including cement and steel as per the specifications (ISI certification marked goods wherever available) shall be the responsibility of the contractor.

**26) Fraud and Corruption**

The World Bank requires compliance with the Bank's Anti-Corruption Guidelines and its prevailing sanctions policies and procedures as set forth in the WBG's Sanctions Framework, as set forth in Section C. In further pursuance of this policy, bidders shall permit and shall cause their agents (whether declared or not), sub-contractors, sub-consultants, service providers, suppliers and their personnel, to permit the Bank to inspect all accounts, records and other documents relating to any initial selection process, prequalification process, bid submission, proposal submission, and contract performance (in the case of award), and to have them audited by auditors appointed by the Bank.

.....

## **SECTION - B**

- 1. Format for Qualification Information.**
- 2. Format for Submission of Bid.**
- 3. Format of Letter of Acceptance.**

**Details of technical documents submitted**

(On bidder's letter head)

<b>Sr. No.</b>	<b>List of documents to be submitted</b>	<b>Document page No</b>
1	Tender fee receipt	
2	Qualification Information (form no 2)	
3	Bid security declaration (Form no 3)	
4	The declaration that the bidder is not black listed/banned by any Government department/ Public Sector Undertaking/ Private Sector/ or any other agency (form no 4)	
5	Declaration about not have Conflict of Interest as mentioned in the ITB 3. (Form No 5)	
6	Turn over certificate issued by the chartered Accountant for financial years i.e. FY 2019-20, 2020-21,2021-22 (Form No 6) or copy of ITRs or balance sheet	
7	Evidence of access to or availability of cash flow or solvency certificate (Form No 7/A or 7/B or 7/C)	
8	Valid license for executing civil works as per appropriate class issued by central or state PWD or any government department	
9	GST registration certificate	
10	Valid electrical license for executing building electrification works	

Signature

Name of Authorized Signatory.....

Bidder's Office Seal

**Note: Bidders should submit this form along with all above mentioned required documents. Each document should be numbered. Employer reserves the right to reject the bid if any of the required documents are not submitted by the bidder along with the bid.**

## QUALIFICATION INFORMATION

### 1 For Individual Bidders

1.1 Principal place of business: \_\_\_\_\_

Power of attorney of signatory of Bid.

**[Attach copy]**

1.2 Total value of Civil\*\* Engineering construction work performed in the last five years (in Rs. Lakhs)

	2018-19: .....
	2019-20:.....
	2020-21:.....
	2021-22:.....
	2022-23:.....
	2023-24:.....

1.3 Work performed as prime contractor (in the same name) on works of a similar nature over the last Five years.

Project Name	Name of Employer	Description of work	Contract No.	Value of contract (Rs. Lakhs)	Date of issue of work order	Stipulated period of completion	*Actual date of completion	Remarks explaining reasons for delay and work completed
1	2	3	4	5	6	7	8	9

\*Completion certificate of Concern Engineer/ authorized person of client should be submitted along with the bid document.

#### Existing commitments and on-going works:

Description of Work	Place & State	Contract No. & Date	Value of Contract (Rs. Lakh)	Stipulated period of completion	Value of works ** remaining to be completed (Rs. Lakhs)	Anticipated date of completion
(1)	(2)	(3)	(4)	(5)	(6)	(7)

\*\* Certificate of concern engineer /authorized person of client should be submitted along with the bid document

**1.4** Proposed subcontracts and firms involved.

<b>Sections of the works</b>	<b>Value of Sub-contract</b>	<b>Sub-contractor (name &amp; address)</b>	<b>Experience in similar work</b>

**1.5** Evidence of access to financial resources to meet the requirement of working capital: cash in hand, lines of credit, etc. List them below and attach copies of supporting documents.

<b>Particulars</b>	<b>Amount</b>	<b>Details</b>
Cash in hand		
Availability of Cash flow		
Other source of fund if any		

**1.6** Name, address, and telephone, telex, and fax numbers of the Bidders' bankers who may provide references if contacted by the Employer.

<b>Name of Bank</b>	<b>Detailed Address</b>	<b>Contact No</b>

**1.7** Information on litigation history in which the Bidder is involved.

<b>Other party(ies) 1</b>	<b>Employer 2</b>	<b>Cause of dispute 3</b>	<b>Amount involved 4</b>	<b>Remarks showing present status 5</b>

If there is NO any litigation, then mention NIL.

**If YES** then mentioned the details column 3 and status in column 5

**1.8** Contract(s) suspended or terminated and/or Performance Security called by an employer(s) for reasons related to Environmental, Social (including sexual exploitation and abuse (SEA) and gender-based violence (GBV)), Health, or Safety (ESHS) performance during the last five years. *(If YES, mention details in the following format)*

<b>Contract(s) suspended or terminated by an Employer(s)</b>			
<b>Year</b>	<b>Contract Identification, Name and address of the Employer, and reasons for suspension or termination</b>	<b>Amount of suspended or terminated portion of contract (Rs)</b>	<b>Total Contract Amount (Rs)</b>
<b>Performance Security called by an employer(s)</b>			
<b>Year</b>	<b>Contract Identification, Name and address of the Employer, and reasons for calling of performance security</b>		<b>Total Contract Amount (Rs)</b>

Signature

Name of Authorized Signatory.....

Bidder's Office Seal

**BID SECURITY DECLARATION**  
**(To be submitted on the Bidder's Letter Head)**

Date: *[insert date]*

Tender Ref No.: SMART/bhumisparsh FPC/Works/10/2023 Dt-29/06/2023

To:

**Bhumisparsh farmer producer Company, Jamb  
Ta. Mohadi Dist. Bhandara**

We, the undersigned, declare that:

We understand that, according to your conditions, quotation must be supported by a Bid-Securing Declaration.

We accept that we will automatically be suspended from being eligible for bidding in any contract with any CBO or project implementing unit under SMART or various offices under various Government organization / World Bank funded Projects for the period of 3 years starting from opening of the financial bids, if we are in breach of our obligation(s) under the bid conditions, because we:

- (a) have withdrawn our Bid during the period of bid validity or
- (b) having been notified of the acceptance of our Bid by the employer during the period of bid validity, (i) fail or refuse to execute the Contract, if required, or (ii) fail or refuse to furnish the Performance Security in accordance with the clauses of bid.

We understand this Bid-Securing Declaration shall expire if we are not the successful Bidder, upon the earlier of (i) our receipt of your notification to us of the name of the successful Bidder; or (ii) twenty-eight days after the expiration of our Bid.

Signature:

Name of person signing bid-security declaration:

Designation:

Name of Bidder:

Date:

Bidder's office Seal:

**FORMAT OF SELF DECLARATION WITH REGARD TO BLACKLISTING/ NON-DEBARMENT & ESHS**

**(To be submitted on the Bidder's Letter Head)**

Date: *[insert date]*

Tender Ref No.: SMART/bhumisparsh FPC/Works/10/2023 Dt-28/06/2023

To:

**Bhumisparsh farmer producer Company, Jamb  
Ta. Mohadi Dist. Bhandara**

We hereby confirm and declare that we, M/s -----, is not blacklisted/ De-registered/ debarred by any Government department /Public Sector Undertaking/ Private Sector/ or any other agency for which we have Executed/ Undertaken the supply goods/ works/ Services during the last 3 years.

We also confirm and declare that no any contract awarded to us have been suspended or terminated and/or performance security called by an employer(s) for reasons related to Environmental, Social (including sexual exploitation and abuse (SEA) and gender-based violence (GBV)), Health, or Safety (ESHS) requirements or safeguards in the past 5 years.

Signature

Name of Authorized Signatory.....

Bidder's Office Seal

**FORMAT OF SELF DECLARATION: NOT HAVE CONFLICT OF INTEREST**  
**(To be submitted on the Bidder's Letter Head)**

Date:

Tender Ref No.: SMART/bhumisparsh FPC/Works/10/2023 Dt-28/06/2023

To:

**Bhumisparsh farmer producer Company, Jamb**  
**Ta. Mohadi Dist, Bhandara**

We hereby confirm and declare that we, M/s -----,  
not have Conflict of Interest as mentioned in the ITB 3. We undertake that we shall be liable  
for any punitive action in case of false declaration.

Signature

Name of Authorized Signatory.....

Bidder's Office Seal

**TURNOVER CERTIFICATE ISSUED BY CHARTERED ACCOUNTANT FIRM  
(on CA's letter head)**

**TO WHOMSOEVER IT MAY CONCERN**

This is to certify that M/s. (name of bidder) is having registered office at (detailed office address). The turnover of the (name of firm) for the following financial years based on the audited financial Statement is as under.

<b>Sr. No.</b>	<b>Financial Year</b>	<b>Turnover in lakhs</b>
1		
2		
3		
4		
5		

The above information/figures are true and authentic to the best of my knowledge and belief. I/we am/ are well aware of the fact that furnishing of any false information/fabricated document would lead to rejection of bid or at any stage, besides liabilities towards prosecution under appropriate law.

Signature of the Chartered Accountant

Name of the Firm

Registration No.

Date:

Place:  
(Seal of the Chartered Accountant)

Email id:

UDIN:

Note:

- 1. Turnover certificate without UDIN shall be rejected.*
- 2. Turnover from unaudited financial statement shall not be considered*

**FORMAT FOR EVIDENCE OF ACCESS TO OR AVAILABILITY OF CASH FLOW**

(To be provided on the letter head of the Bank)

**AVAILABILITY OF CASH FLOW (WORKING CAPITAL)**

This is to certify that M/s. (*mention the name of the bidder*) \_\_\_\_\_ is a reputed contractor/ company with a good financial standing. If the contract for the (*mention the name of work*) \_\_\_\_\_ work is awarded to the above bidder, we shall be able to provide overdraft/credit facilities to the extent of INR \_\_\_\_\_ to meet their capital requirements for executing the above contract.

**Signature of Bank Manager**  
**Name of Bank Manager**  
**Stamp of the Bank**

**SOLVANCY CERTIFICATE ISSUED BY CHARTERED ACCOUNTANT FIRM  
(on CA's letter head)**

**TO WHOMSOEVER IT MAY CONCERN**

We hereby certify that *(Name of the Contractor /company)*, bearing CIN: ..... office at..... *(Office address)* is solvent to the extent of Rs. (Rupees..... Only) as disclosed by the records and documents produced before us and information and explanation given to us.

Signature of the Chartered Accountant

Name of the Firm

Registration No.

Date:

Place:  
(Seal of the Chartered Accountant)

Email id:

UDIN:

*Note: the above format is sample format. solvency certificate issued by CA in their prescribed format is also acceptable provided that the value should not be less than the value mentioned in clause no 2 (e).*

**SOLVENCY CERTIFICATE ISSUED BY BANK  
(on Banks's letter head)**

To,

Date:

Solvency Certificate

At the request of M/s. *(Name of bidder)* ....., we are pleased to confirm that the said customer has been maintaining accounts with the bank. The conduct of the customer's account with the bank has been satisfactory.

We, *(Name of bank)* bank limited ("the bank") does hereby certify that M/s. *(Name of bidder)* ....., situated at having their registered office at .....a customer of the bank and is solvent to the extent of Rs. ..../- (Rupees ..... only) as disclosed by the information and records which are available with the bank as on date.

The above certificate is issued at the specific request of M/s. *(Name of bidder)* .....

**Signature of Bank Manager  
Name of Bank Manager  
Stamp of the Bank**

*Note: the above format is sample format. solvency certificate issued by bank in their prescribed format is also acceptable provided that the value should not be less than the value mentioned in clause no 2 (e).*

**LETTER OF FINANCIAL BID  
(On Bidders Letter head)**

LCB No: SMART/bhumisparsh FPC/Works/10/2023 Dt - 28/06/2023

Date of Bid Submission: .....

To:

**Bhumisparsh farmer producer Company, Jamb  
Ta. Mohadi Dist, Bhandara**

Subject: Submission of financial bid for Construction of CONSTRUCTION OF WAREHOUSE 2000 MT

Sir,

We have no reservations to the LCB document, and offer to execute the Works referred above in accordance with the Conditions of Contract enclosed therewith at a Total Contract Price of

Rs. \_\_\_\_\_ [in figures]

Rs. \_\_\_\_\_ [in words].

This financial bid and your written acceptance of it shall constitute a binding contract between us. We understand that you are not bound to accept the lowest or any bid you receive.

We hereby certify that we have taken steps to ensure that no person acting for us or on our behalf engages in any type of Fraud and Corruption.

We confirm that we bound to comply with (i) the applicable Laws/ Rules/ Regulations for protection of environment, public health and safety; (ii) the regulatory authority conditions (if any) attached to any permits or approvals for the project;

We confirm that, if our bid is accepted, we are responsible to submit and implement the detailed plan to comply the entire requirement mentioned in the annexure -3 with respect to Environmental, Social (including sexual exploitation and abuse (SEA) and gender based violence (GBV)), Health and Safety risks. We also confirm that we have included all cost associated for implementation of this plan in our financial bid.

We hereby confirm that this financial bid is valid for 120 days as mentioned in Instructions to bidders.

We have not been currently debarred or suspended by any Government Organization, the World Bank Group.

Yours faithfully,

Authorized Signature : \_\_\_\_\_ Date signed: \_\_\_\_\_

Name & Title of Signatory : \_\_\_\_\_

Name of Bidder : \_\_\_\_\_

Address : \_\_\_\_\_

**BILL OF QUANTITIES**

The approximate Bill of Quantities is indicated below to give an idea of the work which should be executed in accordance with the approved drawings and specifications to enable the bidder to furnish the Item rate wise price. Bidders may, however, note that no variations in the Item rate cost are acceptable (except where extra items are ordered by the Engineer).

Sr. No	Item	Quantity	Unit	Unit Rate in Rs. inclusive of all duties, GST, other levies etc.		Total Amount in Rs.
				In figures	In words	
<b>A</b>	<b>SW-I- CIVIL WORK</b>					
1	Excavation for foundation in earth, soil of all types, sand, gravel and soft murum, including removing the excavated material up to a distance of 50 m. beyond the building area and stacking and spreading as directed, dewatering, preparing the bed for the foundation and necessary back filling, ramming, watering including shoring and strutting etc. complete. (Lift upto 3.00 m.) By Manual Means	202.80	CUM			
2	Excavation for foundation in earth, soil of all types, sand, gravel and soft murum, including removing the excavated material up to a distance of 50 m. beyond the building area and stacking and spreading as directed, dewatering, preparing the bed for the foundation and necessary back filling, ramming, watering including shoring and strutting etc. complete. (Lift up to 3.00 m.) By Manual Means	121.68	CUM			
3	Providing soling using 80 mm. size trap metal in 15cm. layer including filling voids with crushed sand/grit, ramming, watering etc. complete. Spec. no. As directed by Engineer in charge.	218.25	CUM			
4	Filling in plinth and floors with approved excavated material in 15cm. to 20 cm. layers Including watering and compacting etc. complete	614.91	CUM			
5	Filling in plinth and floors with contractors' material / brought from outside and approved by Engineer In	479.45	CUM			

Sr. No	Item	Quantity	Unit	Unit Rate in Rs. inclusive of all duties, GST, other levies etc.		Total Amount in Rs.
				In figures	In words	
	charge in layers of 15 cm to 20 cm including watering and compaction etc. complete.					
6	Providing earth work embankment with approved materials obtained from other sources up to lead of 50m including all lift slaying in layers of 20cm to 30cm thickness breaking clods, dressing to the requirement lines curves grades ^& sections watering and compaction with vibrator roller with v-s at attachment to achieve not less than 97% of standard proctor Density etc complete Road work	342.00	CUM			
7	Supplying hard murum /kankar at the road side including conveying and stacking complete Road work	342.00	CUM			
8	Supplying soft murum at the roadside including conveying and stacking complete Road work	228.00	CUM			
9	Picking the road surface including sectioning etc. complete (WBM surface.) GORUND FLOOR	228.00	SQMT			
	<b>BD-E: PLAIN CEMENT CONCRETE</b>					
11	Providing and laying Cast in situ/Ready Mix cement concrete in M15 of trap/ granite/ quartzite/ gneiss metal for plain or molded sills, cornice, jambs, block in course, or architraves of required size and shapes including steel centering, formwork, laying/ pumping, compacting, roughening them if special finish is to be provided, finishing uneven and honey combed surface and curing etc. complete. The Cement Mortar 1:3 plaster is considered for rendering uneven and honey combed surface only. Newly laid concrete shall be covered by gunny bag, plastic, tarpaulin etc. (Wooden centering will not be allowed.) with fully automatic microprocessor based PLC with SCADA enabled reversible Drum Type mixer/ concrete Batch mix plant (Pan mixer) etc. complete. With fine aggregate (Crushed sand VSI Grade)	145.50	CUM			
	<b>BD-E: REINFORCED CEMENT CONCRETE</b>					

Sr. No	Item	Quantity	Unit	Unit Rate in Rs. inclusive of all duties, GST, other levies etc.		Total Amount in Rs.
				In figures	In words	
12	Providing and laying in situ /Ready Mix cement concrete M-20 of trap / granite /quartzite/ gneiss metal for R.C.C. work in foundations like raft, strip foundations, grillage and footings of R.C.C. columns and steel stanchions etc. including bailing out water, Steel centering formwork, laying/ pumping cover blocks, compaction and curing roughening the surface if special finish is to be provided (Excluding reinforcement and structural steel)etc. complete, with fully automatic micro processor based PLC with SCADA enabled reversible Drum Type mixer/ concrete Batch mix plant (Pan mixer) etc. complete. With fine aggregate (Crushed sand VSI Grade)	58.08	CUM			
13	Providing and laying Cast in situ/Ready Mix cement concrete M-20 of trap / granite/quartzite/ gneiss metal for R.C.C. columns as per detailed designs and drawing or as directed including steel centering, formwork, cover blocks, laying/pumping, compaction finishing the formed surfaces with cement mortar 1:3 of sufficient minimum thickness to give a smooth and even surface or roughening if special finish is to be provided and curing etc. complete.(Excluding reinforcement and structural steel).with fully automatic micro processor based PLC with SCADA enabled reversible Drum Type mixer/ concrete Batch mix plant (Pan mixer)etc. complete. With fine aggregate (Crushed sand VSI Grade)	14.37	CUM			
14	Providing and laying Cast in situ/Ready Mix cement concrete M-20 of trap / granite/quartzite/ gneiss metal for R.C.C. beams and lintels as per detailed designs and drawings or as directed including steel centering, formwork, cover blocks, laying/ pumping, compaction and roughening the surface if special finish is to be provided and curing etc. complete. (Excluding reinforcement and structural steel). With fully automatic microprocessor-based PLC with SCADA enabled reversible Drum Type mixer/ concrete Batch mix plant	34.84	CUM			

Sr. No	Item	Quantity	Unit	Unit Rate in Rs. inclusive of all duties, GST, other levies etc.		Total Amount in Rs.
				In figures	In words	
	(Pan mixer) etc. complete. With fine aggregate (Crushed sand VSI Grade) GORUND FLOOR					
15	Providing and laying Cast in situ/Ready Mix cement concrete M-20 of trap/ granite/ quartzite/ gneiss metal for R.C.C. chajja as per detailed design and drawings including steel centering, formwork, cover blocks, laying/pumping, compacting and roughening the surface if special finish is to be provided and curing complete. (Excluding reinforcement and structural steel). with fully automatic micro processor based PLC with SCADA enabled reversible Drum Type mixer/ concrete Batch mix plant (Pan mixer) etc. complete. With fine aggregate (Crushed sand VSI Grade) GORUND FLOOR	0.96	CUM			
16	Providing and laying Cast in situ/Ready Mix cement concrete in M-20 of trap/ granite/ quartzite/ gneiss metal for R.C.C. coping to plinth or parapet and sill of doors and windows molded as per detailed drawings or chamfered as approved by the Engineer including steel centering, formwork, cover blocks, laying/pumping, compacting , curing , finishing and roughening them if special finish is to be provided and curing complete. (Excluding reinforcement and structural steel).with fully automatic microprocessor based PLC with SCADA enabled reversible Drum Type mixer/ concrete Batch mix plant (Pan mixer) etc. complete. With fine aggregate (Crushed sand VSI Grade) GORUND FLOOR	4.24	CUM			
17	Providing and laying Cast in situ/Ready Mix cement concrete in M-20 of trap / quartzite /granite /gneiss metal for R.C.C. Waist slab, and steps of staircases as per detailed design and drawings or as directed including steel centering, formwork, steel props, laying/pumping, compaction, finishing uneven and honeycombed surface with C.M. 1:3 of sufficient minimum thickness to give a smooth and even surface or roughening the surface if special finish is to be provided and curing etc. complete.	1.59	CUM			

Sr. No	Item	Quantity	Unit	Unit Rate in Rs. inclusive of all duties, GST, other levies etc.		Total Amount in Rs.
				In figures	In words	
	(Excluding reinforcement, including cover block).(Newly laid concrete shall be covered by gunny bag, plastic, tarpaulin etc.) with fully automatic microprocessor based PLC with SCADA enabled reversible Drum Type mixer/concrete Batch mix plant (Pan mixer) etc. GORUND FLOOR					
18	Providing and fixing in position TMT - FE - 500 bar reinforcement of various diameters for R.C.C. pile caps, footings, foundations, slabs, beams columns, canopies, staircase, newels, chajjas, lintels pardis, copings, fins, arches etc. as per detailed designs, drawings and schedules. including cutting, bending, hooking the bars, binding with wires or tack welding and supporting as required complete.	34.54	MT			
	<b>BD-G : BRICK WORK</b>					
19	Providing second class Burnt Brick masonry with conventional/ I.S. type bricks in cement mortar 1:6 in foundations and plinth of inner walls/ in plinth external walls including bailing out water manually, striking joints on unexposed faces, raking out joints on exposed faces and watering etc. Complete.	18.14	CUM			
20	Providing second class Burnt Brick masonry with conventional/ I.S. type bricks in cement mortar 1:6 in superstructure including striking joints, raking out joints, watering and scaffolding etc. Complete	87.91	CUM			
	<b>BD-L : PLASTER AND POINTING</b>					
21	Providing internal cement plaster 12mm thick in single coat in cement mortar 1:5 without neeru finish to concrete or brick surfaces, in all positions including scaffolding and curing etc.	376.61	SQ.MT			
22	Providing sand faced plaster externally in cement mortar using approved screened sand, in all positions including base coat of 15 mm thick in cement mortar 1:4 using waterproofing compound at 1Kilogramper cement bag	550.40	SQ.MT			

Sr. No	Item	Quantity	Unit	Unit Rate in Rs. inclusive of all duties, GST, other levies etc.		Total Amount in Rs.
				In figures	In words	
	curing the same for not less than 2 days and keeping the surface of the base coat rough to receive the sand faced treatment 6 to 8 mm thick in cement mortar 1:4 finishing the surface by taking out grains and curing for fourteen days scaffolding etc. Complete.					
23	Providing and laying in situ cement concrete M30 with trimix treatment for 200 mm thickness for flooring with groove cutting of 4 mm wide and 20 mm deep with necessary refilling with bitumen etc. Complete GORUND FLOOR	1105.12	SQ.MT			
	<b>BD-P : COLOUR/WASHING, DESTEMPERING</b>					
24	Providing and applying white-wash in two coats on old / new plastered or masonry surfaces and asbestos cement sheets including scaffolding and preparing The surface by brushing and brooming down etc.	927.01	SQ.MT			
25	Providing and applying wash able oil-bound distemper of approved colour and shade to old and new surfaces in two coats including scaffolding, preparing the surfaces.(excluding the primer coat.)etc. complete	376.61	SQ.MT			
26	Providing and applying three coats of water proof cement paint of approved manufacture and of approved color to new plastered surfaces including scaffolding if necessary, cleaning and preparing the surface, watering for two days etc. complete	550.40	SQ.MT			
27	Providing pre constructional anti termite treatment as per I.S.6313(Part- II) by treating the bottom surface and sides of excavation at the rate of 5 liters of emulsion concentrate of 1.0 percent of chlorophyrifos per square meter of surface area covering 10 years Guarantee on bond paper.	1070.00	SQ.MT			
28	Providing and fixing in position factory made box type steel window with glazed fanlight including steel windows of cold rolled section of 105mm x 60mm	14.40	SQ.MT			

Sr. No	Item	Quantity	Unit	Unit Rate in Rs. inclusive of all duties, GST, other levies etc.		Total Amount in Rs.
				In figures	In words	
	x1.25mm thick frame section filled with cement concrete (1:2:4) and metal pressed steel shutters of 20 gauge (1mm) as per detailed drawing and design or as directed including providing horizontal mild steel 12mm square bars at 10cm center to center, required F7 B section, section 76, section 20 mm x 5 mm mild steel flat					
	<b>BD- W : MISCELLANEOUS</b>					
29	Providing and fixing rolling shutter fabricated from steel laths of minimum thickness 0.9 mm with lock plate of 3.15mm thickness reinforced with 35 x 35 x 5 mm angle section fitted with sliding bolts and handles for both sides, deep M.S. channel section of depth and thickness not less than 65 mm and 3.15 mm respectively with hold fast arrangements, M.S. Bracket plate 300 x 300 x 3.15 mm minimum size and shape with square bar, suspension shaft of minimum 32 mm diameter, hood cover of M.S. sheet not less than 0.9 mm thickness and of any size at top and safety devices including mechanical gear operation arrangement consisting of worm gear wheels and worms of high grade cast iron or mild steel and one coat of red lead primer etc. complete. (I.S. 62481979) (With mechanical gear)	48.00	SQ.MT			
30	Providing and fixing lightning conductor system comprising of erecting Air-Termination consisting of tubular copper rod of 25mm dia. 1.2 mm thick with multiple points head 1.2 mt. long (Heavy Duty) welded or clamped to G.I. pipe pole B grade 50mm dia of required length with M.S. round base plate 25cm diam and 10mm thick at bottom embedded in cement concrete 1:3:6 foundation of size 45cm diam x 45 cm Height and providing earthing with copper earth plate of size 60 x 60 x 0.3 cms with cadmium plated nut bolts to fix earthing strip buried in specially prepared earth pits 1.5 metre below ground level with 40 Kilogram charcoal and salt with alternate layers of charcoal and salt and G.I.	1.00	NOS			

Sr. No	Item	Quantity	Unit	Unit Rate in Rs. inclusive of all duties, GST, other levies etc.		Total Amount in Rs.
				In figures	In words	
	pipe 40 mm dia 2 meter length buried in earth up to earthing plate remaining portion above ground level for watering and refilling complete Note-Copper strip from lightning conductor is not considered in this item.					
<b>B</b>	<b>SW-II - Above Plinth - PEB</b>					
1	<b>Structural Steel E-350</b>					
	Supplying, fabricating, erecting and fixing in position of steel structures at all elevations using fusion welding quality steel E-350(Fe490) conforming to IS:2062-2006. Rate shall include cost of cutting, welding, splice plates and packing plates, transporting, straightening, cleaning, fabricating and erecting in position welded/bolted Structural steel work in columns, beams, trusses, purlins, platforms, ladders, monorails, staircases, supports, strengthening of steel members etc. at site to line and level, supply of approved bolts/nuts/washers etc. complete as per drawings including painting as per G4/G5/G6 before erection and all materials and labour charges etc., complete and including Sand blasting & painted with 1 coats of enamel paint (Berger EPILUX SG - HHI 664002) of 35-50 micron each coat with airless praygun over	22.00	MT			
2	<b>Structural Steel-Cold Formed Light gauged</b>					
	Supplying, fabricating and erecting of Cold Formed Light Gauge structural steel members conforming to IS:801/IS:811 hot-dip galvanized to IS:4759 -96 including cutting, welding or bolting, splice plates and packing plates, transporting, straightening, cleaning, Fabricating and erecting in position.	10.00	MT			
3	<b>Sheeting</b>					
	<b>PPGL 0.5 mm thk</b> Supply & Fixing of PPGI sheets of 0.5 mm thick as shown in drawing or as directed by engineer in charge with all necessary accessories.	8.50	MT			

Sr. No	Item	Quantity	Unit	Unit Rate in Rs. inclusive of all duties, GST, other levies etc.		Total Amount in Rs.
				In figures	In words	
4	<b>Roof Accessories</b>					
	Supply & Fixing of 0.5 mm thk PPGL roof accessories as per drawing or as directed by engineer in charge					
	CORNER FLASHING	15.00	RMT			
	Center Ridge	70.00	RMT			
	Gable flashing	58.00	RMT			
5	<b>Roof Gutter</b>					
	Roof Gutter (Assumed Girth-600mm) PPGI 0.5 mm Thk.					
	Supplying, fabricating and erecting in position PPGI Eaves Gutter of required size with stop ends, all fixing accessories, drop ends, etc., at all elevations levels & heights including aligning, leveling, providing and fixing bolts, nuts, washers etc., conforming to latest specification including straightening, cutting, welding, bending to shape, bolting etc., complete and as Directed as per engineer in charge/Construction Manager.	104.80	RMT			
6	<b>Down take Pipe</b>					
	Providing and fixing of the rain water down take pipes of PPGI, the sectional area of rainwater down take pipes provided shall be generally at the rate of 1 square cm per 70 to 80 square decimeter of roof area drained. No spout shall be less than 80 mm in diameter. The spacing of spouts shall be arranged to suit the position of openings in the wall including necessary accessories for fixing the pipe and including all materials and labour charges etc., complete as shown in drawings, as per specifications and as directed by the Engineer-in- Charge/Construction Manager.	140.00	RTM			
7	<b>Polycarbonate Sheet</b>					
	Supply & Fixing of 2mm thk polycarbonate sheets as per drawing & as directed by engineer in-charge.	25.00	SQ.M.			

Sr. No	Item	Quantity	Unit	Unit Rate in Rs. inclusive of all duties, GST, other levies etc.		Total Amount in Rs.
				In figures	In words	
8	<b>Turbo Ventilator</b>					
	Supply & Fixing of turbo ventilator with 610 mm throat, having base ring & top plate in stainless steel of 0.8 mm thick, rotated using twin bearings of SKF - 600122& 600322 permanently lubricated & sealed. Fixed in FRP base plate of 2 mm thk clear 1.020 mtr wide & 1.7 mtr long.	6.00	NOS			
<b>C</b>	<b>SW- IV – Electrification</b>					
1	Supplying, erecting & terminating XLPE armored cable 3 core 6 sq.mm. copper conductor continuous 5.48 sq.mm. (12SWG) G.I. earth wire complete erected with glands & lugs, on wall /trusses /pole or laid in provided trench/pipe as per Specification no. CB-LT/CU	15.00	RMT			
2	Making trench of suitable width and depth in soft soil for laying provided LT cable up to and including 16sq.mm complete as per specification no. CW-EXN- CTR	15.00	RMT			
3	Making trench of suitable width and depth in soft soil for laying provided LT cable up to and including 16sq.mm complete as per specification no. CW-EXN- CTR	10.00	RMT			
4	Supplying & erecting mains PVC unarmored cable 1100 Volt grade ISI mark 3core/2.5sq mm stranded/solid copper complete erected on wall With duly painted G.I. Saddle.	130.00	RMT			
5	Supplying & erecting weatherproof powder coated distribution board 4 way with 2x6/10AmpS.P. M. C. B. with industrial two pin plug socket 10A and 3 pin plug top10A with top cover necessary connection etc complete with Approved make.	8.00	NOS			
6	Providing point wiring for streetlight with PVC unarmored cable1100Volt grade ISI mark 3 core1.5sq mm stranded/ solid copper erected on wall with G.I. Saddle duly painted @ 0,25 m C/C rigidly routed in the wall with the help of plated Screw including 4"x4" M.S. box 2 way with poxy painting &	8.00	NOS			

Sr. No	Item	Quantity	Unit	Unit Rate in Rs. inclusive of all duties, GST, other levies etc.		Total Amount in Rs.
				In figures	In words	
7	Supplying & erecting 10-12 W, 230V integral type LED Lamp suitable for B- 22/E-27 base.	5.00	NOS			
8	Supplying and erecting LED street light fitting suitable for 20 to 25W, with PF>0.95 class IP65 and above housing of pressured i e cast aluminum alloy and heat sink extruded aluminum complete as per specification No FG- ODF/FLS	5.00	NOS			
9	Supplying and erecting streetlight Wall bracket made from 40 mm. dia 'B' class G.I. pipe 1.2m total Length complete as per specification no .FG-BKT/WB	5.00	NOS			
10	Providing earthing with galvanized iron earth plate size 60 x 60 x 0.6 cm complete with all materials, testing & recording the results as per specification no. EA-EP	1.00	NOS			
11	Providing pipe type earthing with 40 mm. dia. G.I. pipe Or 20 mm dia. G.I. Rod complete with all materials as per specification no. EA-EP	1.00	Nos			
12	Supplying, erecting & marking DPMCB 6 A to 32A, C-series (for motor/power) in provided distribution Board as per specification no. SW- SWR/MCB	1.00	NOS			
13	Supplying, erecting & marking SPMC B6 A to 32A, B-series (for lighting) in provided distribution board as Per specification no. SW-SWR/MCB	1.00	NOS			
14	Supplying and erecting GI sheet 1.6 mm (16SWG) to be used for fabrication of boxes panel boards etc. including cutting, bending, drilling, welding, Riveting etc. and painting with one coat of red lead paint and 2 coats of enamel paint.	1.00	NOS			
15	Supplying and erecting marine plywood 18/19 mm thick fixed to wall or on provided panel board with necessary materials such as screws, wall fasteners, supports, nut bolts etc. complete.	1.00	NOS			
16	Supplying and erecting triple pole and neutral distribution board (TPNDB) surface / flush mounted suitable for SPMC B of 12 ways on iron/ GI frame (horizontal bus bar type) as per Specification no. SW-SWR/MCBDB	1.00	NOS			

Sr. No	Item	Quantity	Unit	Unit Rate in Rs. inclusive of all duties, GST, other levies etc.		Total Amount in Rs.
				In figures	In words	
17	Supplying & erecting G.I. pipe 'A' class 25 mm dia. Erected for enclosing XLPE armored cable on wall/pole as per specification no. CB-CE	20.00	RMT			
18	Supplying & erecting G.I. pipe 'A' class 40 mm dia. Erected for enclosing XLPE armored cable on wall /pole as per specification no. CB-CE	12.00	RMT			
19	Supplying and laying (including excavation of suitable width & depth up to 90 cm ) 75 mm outside dia. double wall corrugated pipes (DWC) of HDPE for enclosing cable below ground/road surface, to required depth complete.	25.00	RMT			
20	Supplying & erecting 18 gauge M.S. Box powder coated (4"x4") 3 way for mains connection.	8.00	Nos			
21	Supplying & erecting Siemens type brass cable glands for 3 to 4 core 6 sq.mm. /2 to 4 core 10 sq.mm. for XLPE armored cable as per specification No. CB- GL	6.00	Nos			
22	Supplying shock proof type hand lamp with lamp holder, bulb/ lamp 100W guarded glass and 30 mtr. 3 core PVC flexible cord with hand shield type 3 pin 6Amp . Plug top.	6.00	Nos			
23	Point wiring for independent plug in 20 mm ISI marked HMS PVC conduit with 1.5 sq.mm (2+1E) FRLSH grade copper wire, flush type switch, earthing and required accessories as per specification No: WG- PW/SW	6.00	Nos			
24	Supplying and erecting Streetlight bracket made from 25 mm. dia_ B 'class G.I. Pipe, 0.6 min length along with pole cap of 300 mm length and 80 mm Dia duly welded with provided leads as per specification FG- BKT/BPC	8.00	Nos			
25	Supplying & erecting mains with 2x2.5 Sq. mm stranded copper PVC insulated wire with 2 x 1.5 Sq.mm copper PVC wire in PVC casing-caping 20 Mm on wall/ceiling.	8.00	RMT			
26	Supplying & erecting main with 2x4.00 Sq.mm stranded copper PVC insulated wire with 2 x 1.5 Sq.mm copper PVC wire in PVC casing- caping on Wall / ceiling.	8.00	RMT			
27	Supplying and erecting double poles witch surface type /flush type 240 V, 32A with indicator lamp & fuse as per specification no. SW-SWR/BDP.	10.00	Nos			

Sr. No	Item	Quantity	Unit	Unit Rate in Rs. inclusive of all duties, GST, other levies etc.		Total Amount in Rs.
				In figures	In words	
28	Supplying and erecting double pole metal clads witch with HC type fuse and neutral link 240V,32Aoniron/ GI frame as per specification no. SW-SWR/MDP..	8.00	Nos			
29	Supplying & erecting 3W, 230 V integral type LED Lamp suitable for B-22/ E-27 base.	8.00	Nos			
30	Supplying and erecting T8 Fluorescent tube day light 1200 mm 36 W	6.00	Nos			
31	Supplying & erecting ready to use Retrofit T 8 LED 18/20 tube light with polycarbonate body, heatsink, integrated HF electronic driver complete & Compatible to T8/T12 LED luminaire by disconnecting starter & ballast if necessary.	8.00	Nos			
32	Supplying and erecting regular/ standard model ceiling fan of 900 /1050 mm. sweep complete erected in position as per specification FG- FN/CF	10.00	Sqm			
33	Supplying and fixing wire mesh (Jali) cover suitable for fitting / fan or for any purpose, complete with necessary materials. The jali cover shall be made from good quality G.I. wire mesh	8.00	Nos			
34	Supplying and erecting dingdong/electronic musical type call bell with heavy duty coil suitable to operate on 230 VA.C. supply erected on polished Double wooden block/sun mica	6.00	Nos			
	Block of suitable size					
35	Supplying and erecting streetlight Wall bracket Made from 25 mm. dia 'B' class G.I. pipe 1.2 min total length complete as per specification no. FG- BKT/WB	6.00	Nos			
36	Supplying & erecting CRCA sheet metal one way enclosures suitable for DPMCB/TPMCB/FPMCB Erected on angle iron/GI frame complete.	1.00	Nos			
37	Supplying erecting and marking four pole isolate or sonly switch version of miniature circuit Breakers of 40 A in provided distribution board complete.	1.00	Nos			
<b>C</b>	<b>SW-III - ROYALTY</b>					

Sr. No	Item	Quantity	Unit	Unit Rate in Rs. inclusive of all duties, GST, other levies etc.		Total Amount in Rs.
				In figures	In words	
1	FOR SAND	142.00	Cu.M.			
2	FOR OTHER METAL	1482.25	Cu.M.			
<b>D</b>	SW-IV - LAB TESTING					
1	CEMENT; -Fineness, Consistency, Setting Time, Compressive strength, Specific gravity.	1	No.			
2	M20 CONCRETE; -i) Mix Design with all tests on basic materials	1	No.			
3	ii)Concrete cube compressive strength	5	No.			
4	iii) Rebound hammer Test	2	No.			
5	M15 CONCRETE; -i) Mix Design with all tests on basic materials	1	No.			
6	ii)Concrete cube compressive strength	5	No.			
7	MAETAL FOR ROAD; -i) Water absorption, Specific gravity, Impact value, Crushing value	1	No.			
8	iii) Combined Flakiness & Elongation of single metal	1	No.			
9	BRICKS: -Water Absorption (Set of 5 Bricks), Compressive strength (Set of 5 Bricks), Efflorescence (Set of 5 Bricks)	1	No.			
10	STONE MASONARY: -Crushing value, / compressive strength, water absorption, Specific Gravity.	1	No.			
11	TMT STEEL: -Yield stress, ultimate tensile stress, elongation, weight per running meter.	1	No.			
12	SAND :-i) Fineness Modulus, silt content.	1	No.			

Sr. No	Item	Quantity	Unit	Unit Rate in Rs. inclusive of all duties, GST, other levies etc.		Total Amount in Rs.
				In figures	In words	
13	MURUM; -ii) Atterberg Limit	1	No.			
VII	Management Strategies and Implementation Plan (MSIP) to manage the Environmental, Social, Health and Safety (ESHS) risks and ESHS Code of Conduct	Lump Sum				
<b>Total Amount inclusive of all in Rs.</b>						

Note: The total amount mentioned in the form-8 should be same as mentioned in the BOQ.

We agree to execute the works in accordance with the terms and conditions mentioned in the LCB document, approved drawings and technical specifications at a total fixed contract price of Rs..... /- (amount in figures) (Rs. ....only amount in words).

Signature  
Name of Authorized Signatory.....  
Bidder's Office Seal

## **Management Strategies and Implementation Plan (MSIP) to manage the Environmental, Social, Health and Safety (ESHS) risks and ESHS Code of Conduct**

The policy goal, as a minimum, shall be to integrate environmental protection, forest and biodiversity conservation, pollution prevention, promote resource use efficiency, waste management, community health and safety measures and protection of cultural heritage sites during designing and execution of the civil works. It is also to promote gender equality, child protection, vulnerable people (including those with disabilities), sexual harassment, gender-based violence (GBV), sexual exploitation and abuse (SEA), HIV/AIDS awareness and prevention in the planning processes, programs, and various activities involved in the execution of the works.

The Bidder shall accordingly submit a comprehensive and concise Management Strategies and Implementation Plan (MSIP) to manage the Environmental, Social (including sexual exploitation and abuse (SEA) and gender-based violence (GBV), Health and Safety (ESHS) risks, and ESHS Code of Conduct.

The Plan shall include;

1. Management of construction debris (silt, oil, solid waste, wastewater, etc.) and traffic management plan to ensure safety of local communities and ecosystem from construction activities
2. Abatement plan for environmental pollution, re-vegetation of construction site and sensitization of workforce
3. Water resource protection plan to prevent contamination of drinking water;
4. Boundary marking and protection strategy to prevent depositing on private land and offsite adverse impacts;
5. Gender based violence and sexual exploitation and abuse (GBV/SEA) prevention and response action plan
6. Mobilization strategy
7. Worker's camp management plan including the process for mitigating construction related impacts on local community
8. Occupational health and safety plan of the workforce
9. Child Protection Plan
10. Capacity building/training Plan
11. HIV/AIDS awareness and prevention plan
12. Prevention and mitigation plan of COVID-19

The plan shall describe the actions, materials, equipment, management processes, including costs etc. that will be implemented by the Contractor, and its subcontractors.

The Bidder shall document and submit the Code of Conduct that will apply to its employees and subcontractors, to mitigate ESHS risks and to ensure compliance with its Environmental, Social, Health and Safety (ESHS) obligations under the contract.

In addition, the Bidder shall submit an outline of how this Code of Conduct will be implemented and availability of qualified and trained personnel to supervise and implement the action plan. This will include how it will be introduced into conditions of employment/engagement, what training will be provided, how it will be monitored and how the Contractor proposes to deal with any breaches.

For details, please refer to the chapter no. 11 on the Construction Management Guideline and chapter no 14 on Labour Management Framework of the SMART project's Environment & Social Management Framework (ESMF) report. For accessing ESMF report,

please visit [https://www.smart-mh.org/cdn//2019/08/190818171526\\_405e\\_4be\\_8b9\\_d3ce2374fe29ce1561a62b.pdf](https://www.smart-mh.org/cdn//2019/08/190818171526_405e_4be_8b9_d3ce2374fe29ce1561a62b.pdf) and for EHS guideline visit <http://documents1.worldbank.org/curated/en/157871484635724258/pdf/112110-WP-Final-General-EHS-Guidelines.pdf>

**LETTER OF ACCEPTANCE  
CUM NOTICE TO PROCEED WITH THE WORK  
(LETTER HEAD OF THE EMPLOYER)**

Dated: \_\_\_\_\_

To: \_\_\_\_\_ [Name and address of the Contractor]  
\_\_\_\_\_  
\_\_\_\_\_  
\_\_\_\_\_

Dear Sirs,

This is to notify you that your Bid dated \_\_\_\_\_ for execution of the \_\_\_\_\_ for the contract price of Rupees \_\_\_\_\_ [amount in words and figures], is hereby accepted by us.

You are hereby requested to furnish performance security for an amount of Rs. \_\_\_\_\_ (equivalent to 3% of the contract price) within 15 days of the receipt of the letter. The Performance Security in the form of Bank guarantee or a Bank draft in favour of .....(Employer) shall be valid until date 28 days after the date of issue of the Certificate of Completion i.e., up to \_\_\_\_\_. Failure to furnish the Performance Security will entail cancellation of the award of contract.

You have to submit detailed ESHS compliance plan within one week from the date of this letter of acceptance. Failure to submit the acceptable ESHS plan will entail cancellation of the award of contract.

You are also requested to sign the agreement form and proceed with the work not later than \_\_\_\_\_ under the instructions of the Engineer, \_\_\_\_\_ and ensure its completion within the contract period.

With the issuance of this acceptance letter and you're furnishing the Performance Security, contract for the above said work stands concluded.

Yours faithfully,

**Authorized Signature  
Name and title of Signatory**

**Draft Agreement form for  
ARTICLES OF AGREEMENT**

1. This deed of agreement is made in the form of agreement on \_\_\_\_\_ day \_\_\_\_\_ month \_\_\_\_\_ 20 \_\_, between the \_\_\_\_\_ (Employer) or his authorized representative (hereinafter referred to as the first party) and \_\_\_\_\_ (Name of the Contractor), S/O \_\_\_\_\_ resident of \_\_\_\_\_<sup>1</sup> (hereinafter referred to as the second party), to execute the work of construction of \_\_\_\_\_ (hereinafter referred to as works) on the following terms and conditions.

**2. Cost of the Contract**

The total cost of the works (hereinafter referred to as the “total cost”) is Rs. ....../- as per the final contract amount /amount reflected in final BOQ.

**3. Payments under the contract:**

Payments to the second party for the construction work will be released by the first party in the following manner: -

1 <sup>st</sup> R. A. Bill	25% of the total cost
2 <sup>nd</sup> R. A. Bill	20% of the total cost
3 <sup>rd</sup> R. A. Bill	20% of the total cost
4 <sup>th</sup> R. A. Bill	20% of the total cost
Final Work Completed as per Tender	15% of the total cost

**3.1 (Not Applicable)**

3.2 The Employer shall retain (Retention Money) 6% of the amount from each payment due to the Contractor subject to the maximum of 5% of final contract price. Half of the amount retained shall be repaid upon completion of the works, and other half shall be repaid when the Defects Liability Period has passed and the Engineer has certified that all Defects notified to the Contractor before the end of this period have been corrected. On completion of the whole works the Contractor may substitute the balance retention money with an “on demand” Bank guarantee.

3.3 Payments at each stage will be made by the first party:

- (a) on the second party submitting an invoice for an equivalent amount;
- (b) on certification of the invoice (except for the first installment) by the engineer nominated by the first party with respect to quality of works in the format in Annexure - 1; and
- (c) upon proper and justified utilization of at least 50 % of the previous installment and 100 % of any prior installment.

**4. Notice by Contractor to Engineer**

---

<sup>1</sup>In case of a firm insert ‘complete address of the firm’. In case of an individual contractor insert identification like ‘son of and resident of’ etc.

The second party, on the works reaching each stage of construction, shall issue a notice to the first party or the Engineer nominated by the first party [who is responsible for supervising the contractor, administering the contract, certifying payments due to the contractor, issuing and valuing variations to the contract, awarding extension of time etc.] to visit the site for certification of stage completion. Within 15 days of the receipt of such notice, the first party or the engineer nominated by it, will ensure issue of stage completion certificate after due verification.

**5. Completion time**

The works should be completed in 8 Month from the date of this Agreement. In exceptional circumstances, the time period stated in this clause may be extended in writing by mutual consent of both the parties.

**6.** If any of the compensation events mentioned below would prevent the work being completed by the intended completion date, the first party will decide on the intended completion date being extended by a suitable period:

- a) The first party does not give access to the site or a part thereof by the agreed period.
- b) The first party orders a delay or does not issue completed drawings, specifications or instructions for execution of the work on time.
- c) Ground conditions are substantially more adverse than could reasonably have been assumed before issue of letter of acceptance and from information provided to second party or from visual inspection of the site.
- d) Payments due to the second party are delayed without reason.
- e) Certification for stage completion of the work is delayed unreasonably.

**7.** Any willful delay on the part of the second party in completing the construction within the stipulated period will render him liable to pay liquidated damages @ 0.05 % of the contract value of the work per day which will be deducted from payments due to him. The first party may cancel the contract and take recourse to such other action as deemed appropriate once the total amount of liquidated damages exceeds 5 % of the contract amount.

**8. Duties and responsibilities of the first party**

**8.1** The first party shall be responsible for providing regular and frequent supervision and guidance to the second party for carrying out the works as per specifications. This will include written guidelines and regular site visit of the authorized personnel of the first party, for checking quality of material and construction to ensure that it is as per the norms.

**8.2** The first party shall supply 3 sets of drawings, specifications and guidelines to the second party for the proposed works.

**8.3** Possession of the site will be handed over to the second party within 10 days of signing of the agreement.

**8.4** The Engineer or such other person as may be authorized by the first party shall hold meeting once in a month where the second party or his representative at site will submit the latest information including progress report and difficulties if any, in the execution of the work. The whole team may jointly inspect the site on a particular day to take stock of activities.

**8.5** The Engineer shall record his observations/instructions at the time of his site visit in a site register maintained by the second party. The second party will carry out the instructions and promptly rectify any deviations pointed out by the engineer. If the deviations are not rectified, within the time specified in the Engineer's notice, the first party as well as the engineer nominated by it, may instruct stoppage or suspension

of the construction. It shall thereupon be open to the first party or the engineer to have the deviations rectified at the cost of the second party.

- 8.6** The Engineer shall issue a Certificate of Completion of the Works on the request of the second party, and upon deciding that the whole of the Works is completed.

## **9. Duties and responsibilities of the second party**

### **9.1** The second party shall:

- a) take up the works and arrange for its completion within the time period stipulated in clause 5;
- b) employ suitable skilled persons to carry out the works;
- c) regularly supervise and monitor the progress of work;
- d) abide by the technical suggestions/ direction of supervisory personnel including engineers etc. regarding building construction;
- e) be responsible for bringing any discrepancy to the notice of the representative of the first party and seek necessary clarification;
- f) ensure that the work is carried out in accordance with specifications, drawings and within the total of the contract amount without any cost escalation;
- g) keep the first party informed about the progress of work;
- h) correct the notified defects within the length of time specified by the Engineer;
- i) be responsible for all security and watch and ward arrangements at site till handing over of the works to the first party;
- j) maintain necessary insurance against loss of materials/cash, etc. or workman disability compensation claims of the personnel deployed on the works as well as third party claims from the start date to the end of defect liability period;
- k) pay all duties, taxes and other levies payable by construction agencies as per law under the contract (First party will effect deduction from running bills in respect of such taxes as may be imposed under the law);
- l) abide by the regulatory authority conditions (if any) attached to any permits or approvals for the project; and the ESHS Management Strategies and Implementation Plan and ESHS Code of Conduct, if any prescribed by the Employer;
- m) abide by all labour enactments and rules made there under, regulations, notifications and bye laws of the State or Central Government or local authorities;
- n) abide by all enactments on environmental protection and rules made there under, regulations, notifications and by-laws of the State or Central Government, or local authorities;
- o) be responsible for the safety of all activities on the Site.

## **10. Variations / Extra Items**

The works shall be executed by the second party in accordance with the approved drawings and specifications. No variation in cost is acceptable. However, if the Engineer issues instructions for execution of extra items, the following procedure shall be followed:-

- a) The second party shall provide the Engineer with a quotation for carrying out the extra items when requested to do so by the Engineer. The Engineer shall

assess the quotation, which shall be given within seven days of the request before the extra items are ordered.

- b) If the quotation given by the second party is unreasonable, the Engineer may order the extra items and make a change to the Contract Price which shall be based on Engineer's own forecast of the effects of the extra items on the Contractor's costs.
- c) The second party shall not be entitled to additional payment for costs, which could have been avoided by giving early warning.

## **11. Securities**

The Performance Security shall be provided to the Employer no later than the date specified in the Letter of Acceptance and shall be issued in an amount and form and by a bank acceptable to the Employer. The Performance Security shall be valid until a date 28 days from the date of issue of the Certificate of Completion in the case of a Bank Guarantee.

## **12. Termination**

- 12.1 The Employer may terminate the Contract if the other party causes a fundamental breach of the Contract.
- 12.2 Fundamental breaches of Contract include, but shall not be limited to the following:
  - (a) the contractor stops work for 28 days and the stoppage has not been authorized by the Engineer;
  - (b) the Contractor has become bankrupt or goes into liquidation other than for a reconstruction or amalgamation;
  - (c) the Engineer gives Notice that failure to correct a particular Defect is a fundamental breach of Contract and the Contractor fails to correct it within a reasonable period of time determined by the Engineer;
  - (d) the Contractor does not maintain a security which is required;
  - (e) the Contractor has engaged in Fraud and Corruption as defined in Section C, in competing for or in executing the Contract; and
  - (f) the contractor has delayed the completion of the Works by the number of days for which the maximum amount of liquidated damages can be paid
- 12.3 Notwithstanding the above, the Employer may terminate the Contract for convenience.
- 12.4 If the Contract is terminated the Contractor shall stop work immediately, make the Site safe and secure and leave the Site as soon as reasonably possible.

## **13. Payment upon Termination**

- 13.1 If the Contract is terminated because of a fundamental breach of Contract by the Contractor, the Engineer shall issue a certificate for the value of the work done less advance payments received up to the date of the issue of the certificate, less other recoveries due in terms of the contract, less taxes due to be deducted at source as per applicable law.
- 13.2 If the Contract is terminated at the Employer's convenience, the Engineer shall issue a certificate for the value of the work done, the reasonable cost of removal of Equipment, repatriation of the Contractor's personnel employed solely on the Works, and the Contractor's costs of protecting and securing the Works and less advance payments received up to the date of the certificate,

less other recoveries due in terms of the contract and less taxes due to be deducted at source as per applicable law.

**14. Dispute settlement**

If over the works, any dispute arises between the two parties, relating to any aspects of this Agreement, the parties shall first attempt to settle the dispute through mutual and amicable consultation.

In the event of agreement not being reached, the matter will be referred for arbitration by a Sole Arbitrator not below the level of retired Chief Engineer / Superintending Engineer, (not connected in part or whole with this Project in his service) to be appointed by the first party. The Arbitration will be conducted in accordance with the Arbitration and Conciliation Act, 1996. The decision of the Arbitrator shall be final and binding on both the parties.

**15. Fraud and Corruption**

The World Bank requires compliance with the Bank's Anti-Corruption Guidelines and its prevailing sanctions policies and procedures as set forth in the WBG's Sanctions Framework, as set forth in Section C. In further pursuance of this policy, the Contractor shall permit and shall cause its sub-contractors, sub-consultants, service providers, suppliers, agents' personnel, to permit the Bank to inspect all accounts, records, and other documents relating to the procurement process, selection and/or contract execution, and to have them audited by auditors appointed by the Bank.

**16. Approved rates:** As per the attached annexure

**Annexure I**

**Format of certificate**

Certified that the works up to ----- level in respect of construction of ----- at ----- have been executed in accordance with the approved drawings and technical specifications.

Signature  
Name & Designation  
(Official address)

Place:  
Date:

Office seal

## **Annexure-2 Technical Specifications**

### **Specifications & Performance Requirements**

Note

(1) Concrete, Steel, Paints etc shall conform to the I.S.I expert otherwise specified.

(2) The Mode of measurement shall generally follow I.S. 1200 (Revised) along with other applicable parts except otherwise specified.

**Scope of work :** The work contemplated under this contract includes general Builder, work for the aforesaid project, all as detailed in the Bill of Quantities, Specifications and drawings and to complete the said work in every respect in accordance with this contract and with the directions and to the satisfaction of the Engineer-in-charge. Such other works which are not included in the aforesaid Bill of quantities are generally intended to be executed through a separate agency. Notwithstanding the above, the Engineer-in-Charge reserves the right to order additional works under the same Contract. The Engineer-in-charge also reserves the right to omit any item of work included in the aforesaid Bill of quantities and award the same to any other contractor or not perform it at all at his discretion and the Contractor shall not have any claim because of the same. The Contractor for this work shall be required to work in co-operation and co-ordination with other agencies on site and give them all reasonable assistance and help for the execution of the work in an efficient manner all as directed. The words "approved" or "as directed" shall be deemed to convey approval or the discretion of the Engineer-in-charge of the work.

**1.1.2 Indian Standard Specification:** The particular Specifications for the work are as detailed hereinafter. These specifications shall be read in conjunction with the relevant Indian Standard Specifications. The obtainable local practice as detailed in various regional handbooks of practice may be used subject to specific approval from the Engineer-in-charge. Where the specifications in any of the standards are at variance with the specifications detailed herein, the specifications herein shall govern.

**1.1.3 Quality of Materials & General Standards of work:** The contractor under this contract commits himself to use materials conforming to relevant Indian Standards / Codes and assumes full responsibility for the quality of all materials incorporated or brought for incorporation in the work, the work shall be executed in accordance with acceptable engineering practice and as per direction of the Engineer-in-charge.

**1.1.4 Scaffolding:** All scaffolding and ladders required for the proper execution of the work shall be provided by the contractor. The scaffolding should be stout and strong to prevent any collapse or displacement. Proper measures for safety of workmen working on scaffolding should be taken by the contractor. The mode of measurements, wherever possible is specifically mentioned in these documents. Where it has not been mentioned, it shall be as per provision of the relevant Indian Standards. All the measuring tapes and other accessories necessary, shall be provided by the contractor.

The bidder along with his bid shall furnish a list of tools, plant and machinery which he intends to use on the works in Bid document. The list should indicate the exact type of machine, its capacity, year of manufacture, kind and capacity of propelling force, spare parts readily available and all other pertinent information. The contractor is obliged to use the machinery mentioned in his list if the Engineer-in-charge considers it necessary.

**1.1.5 Surveying and staking** : It is the express responsibility of the contractor to bring to site all surveying instruments necessary for the marking out, fixation of levels, etc. and conduct these survey operations himself with utmost accuracy. The contractor shall put up stable bench marks etc. as necessary for the work. Engineer-in-charge / his representative will be present when this work is being carried out and will inspect all these operations with the contractors assistance. The contractor shall be entirely responsible for accurate setting out the work and he shall at his own expense make good any defects arising from errors in the line and levels.

**1.1.6 Dewatering:** Dewatering of accumulated water in all locations on work site from whatever source of cause until the virtual completion of the entire work shall be done by the contractor at his own expenses and shall not be separately paid for. The rates quoted by the contractor shall be deemed to be inclusive of this.

**1.1.7 Access to site, approach roads and roads within the premises** : The contractor shall at his own cost provide all approach roads required for the purpose of carrying out the work in the most expeditious and efficient manner and shall remove the temporary roads on completion. He shall acquaint himself thoroughly regarding condition and suitability of public roads leading up to the limits of the premises and will provide vehicles for transportation of materials which meet the requirements of these road conditions. It shall also be the responsibility of the contractor to maintain at his own cost the road till the construction is completed. The bidder is also to acquaint himself with local laws and bylaws and comply with all police and highway authority requirements.

## **DETAILED SPECIFICATION** **SECTION-A.**

### **EXCAVATION IN SOFT STRATA & HARD STRATA**

The excavation shall be carefully done to the levels, shapes and dimensions as shown in figures on the Drawings or as required by the Architect to receive bed concrete. Should any of the excavation be taken down below the proper levels the contractor shall fill in such excavation if so instructed by Architect at his own expenses with M-100 concrete, well rammed in position until it is brought upto the proper level. Filling in with excavated material will not be allowed for this purpose, however the Architect's decision shall be final in such cases.

If the foundation pits and trenches are made broader or longer than that shown on drawings, the extra breadth and length shall be filled in with earth, rammed hard after the foundation are built. The contractor shall at his own expense and without extra charge, make provision for all shoring, strutting, pumping, dredging or bailing out water. The foundations shall be kept free from water while the work is in progress. The contractor shall also remove such portions of boulders' 'or rock, as are required to make the bottom of the foundations horizontal and level. The foundations shall be inspected and, passed by, the Architect before any filling work is commenced.

The excavated useful stuff shall be used for filling up the sides of the foundations and between the plinth walls in layers not exceeding 23cm. properly rammed and watered. All surplus earth left over shall be either spread or deposited on the site as required by the Architect shall be carted away at places directed by the Architect. However, contractor would be paid for this work as per the Tender Rate.

### **MODE OF MEASUREMENT AND PAYMENT**

The measurements of work shall be exact length, width and depth of the foundations according to and as shown on the Drawings. (if the Architect and the depth shall be measured vertically. It shall be paid per Cubic Meter, and the work shall be measured as per Drawings only. Any excavation shall include labour for excavation, spreading or stacking the excavated stuff within a radius of 15 Mtr. 011 site of work. No extra shall be allowed for planking and strutting or shoring of sides of excavation provided for prevention the sides from sliding.

### **EXCAVATION IN ROCK**

Cutting in rock shall be done either by blasting or chiselling, as directed, to the required widths, depths and lengths. As far as possible the beds should be made in level.

### **MODE OF MEASUREMENT**

Rock excavation, shall be measured by working out levels before and after excavation measured from a permanent Bench Mark, The rates shall be per Cubic meter. In case of small work of rock excavation the measurements of excavated rock shall be made with stacks which shall be made with the spoils without leaving any voids and the rate shall be per Unit of one Cubic Meter. All excavation shall be done as per Drawings and to the required width, breadth and depth. A deduction of 20% shall be made in measurements for voids if work is measured by stack measurements. The spoils of rock excavation will be the property of the Employer.

Contractor has to obtain necessary permission in writing for blasting from the concerned Govt. Authorities parties if required, before commencement of blasting work and during execution. However, Employer may make use of his good offices in giving necessary assistance to contractor in obtaining such permission if so desired by the contractor.

Contractor has to pay all the necessary fees for obtaining such permission for blasting.

## **SECTION - B**

NOTE: Wastage: The contractor shall allow in his rates for all wastages in all materials, used or to be used for this work by him.

### **Stone**

Stone for rubble masonry shall be the best of its kind; sharp angles and free from flakes, of quality approved by the Architect.

Stone for cut stone work or masonry work shall be the best of its kind, should, durable, free from flows, cracks, veins, crystals, minerals, salt, cavities or other defects and it shall be of uniform texture. No earthy discolored or weathered or water born stones shall be used. , All stone's shall be laid on their natural beds and properly bounded in the work. It shall be from a quarry approved by the Architects. Stones should conform to relevant I.S. specifications.

### **Sand**

Sand to be used in concreting shall be clean and of approved quality and from approved places by Architect, free from salt, dust or other impurities. It shall be washed with clean water if required, before use. Screened sand shall be used for plaster and masonry, work. sand should conform to I.S. specifications. No extra charges shall be paid for washing or screening or wastage of sand.

### **Metal**

Metal or concrete in foundation work shall not be larger than 40 mm gauge or smaller than 25 mm and should be free from all dust or earthy substances and of stone approved by the Architects. Flat stone chippings shall be rejected. Metal for R.C.C. work No.1 may be 6 mm. to 12mm. and No.2 may be 12 mm. to 20 mm size (Coarse, aggregate in R.C.C.) The larger aggregate (No.2) shall pass through 25 mm diameter mesh but not through 12 mm dia

mesh. The smaller aggregate (No.1) shall pass through 12mm. dia mesh but not through 5 mm, dia mesh. Metal No.3 for plain cement concrete may be 40 mm to 25 mm. and shall pass through 40 mm. dia mesh but not through 25 mm dia mesh, The crushing strength of the metal shall be as per I.S. specifications or metal shall be as per I.S. specifications. All metal shall be of approved quality by the Architect.

#### **Neeru**

Neeru made cut of the best quality material. The lime shall be reduced to fine powder by grinding in a mortar mill with 160 turns. The neeru shall be kept moist until used and no more than that can be consumed in a week shall be prepared at a time. Before using the neeru, it should be prepared at a time. Before using the neeru It should be tested to see that, there are no unslaked particles, and it should be got approved from the Architect. 'Sagol' if it is of quality approved by the Architects shall be used in place of neeru. Neeru shall be sieved with fine saive before mixing with water.

#### **LIME**

The best quality of hydraulic lime from a locality approved by the Architects, properly burnt, shall be slacked, with fresh water on the site and used on works. The lime shall be free from unburnt kankar, ashes and oilier impurities including salt. Lime should conform to I.S. specifications.

#### **BRICKS**

Bricks shall be well burnt of a quality approved by the Architects, free from lumps or grit, well. burnt sound, hard and with sharp edges and shall give a ringing sound when struck with a mallet. they, should be of uniform size. No brick after 24 hours immersion in water shall absorb water more than 15% of its weight. The size of bricks shall be as per standard practices and approved by the Architects, The bricks should conform to I.S. specifications.

#### **TIMBER**

Timber shall be of best quality teak wood or as specified in the schedule of quantities, of the best descriptions, perfectly dry, well-seasoned, free from sap wood, sound, straight, free from large and loose knots; cracks, shakes and other defects and any appearance of rot. It shall be of a quality approved by the Architects. Ply wood shall be of standard make and approved by the Architects.

Large and loose knots, cracks, shakes and other defects and any appearance of rot. It shall be of a quality approved by the Architects. Ply wood shall be of standard make and approved by the Architects.

#### **MILD STEEL, TORSTEEL, STRUCTURAL STEEL ETC.**

All steel work shall comply with the Indian standard specifications for structural steel as well as that for reinforcement. The surface shall be free from rust. All steel shall be in tested and shall be Tata's or other equivalent manufacturers and approved by Architect. All steel shall confirm with latest IS-226 and IS-432 as applicable. All steel shall be tested in Laboratory before putting it to use and use results shall be submitted to the Architect for approval. If test results are not upto the standard, then Architect may reject the steel.

Reinforcing bars and rods 6 mm. or higher in dia metre, shall be supplied by the Employer if possible and the rates and place of delivery mentioned in Schedule-A of the Tender documents.

The Bars and Rods shall be supplied according to the available lengths and the supply shall be at the rate stipulated in Schedule-A or the Tender documents.

The Contractor shall place firm indents of his monthly requirements not less than three months in advances. The contractor shall be responsible for all consequences that may arise of his failure to comply with these requirements of the procedure that may be laid therefore.

The contractor shall make suitable arrangements for storage of steel supplied by the

Employer. The Employer's representative shall have the authority at all times to inspect the storage, arrangements and to suggest modifications and improvements if any, and the contractor shall comply with the same.

The storing, arrangements shall be such as to afford convenience of the inspection and check of materials. Bars of the same size, length, shape and grade shall be assembled in stack and marked distinctly.

The contractor shall at all times maintain proper records showing the basis of indents, the receipts and the utilization of the steel supplied by the Employer and these shall at all times be open for inspection by the Architects.

The steel bars shall be issued on the basis of weight of steel. The weight shall be arrived at by measuring the lengths of the bars and multiplying by same by the standard weights as per unit length given in the Table below, "for any other sizes not included in the Table, standard weights as per the manufacturers catalogues shall be used. The lengths shall be measured to the nearest ten cms any fractions of less than 5 cms, being neglect and fractions of 5 cms. or above taken as 10 cms.

**TABLE**

Sections rolled in Metric System.

Bars of diameter in mms	Weight in Kg, per Running Metre.
6	0.22
10	0.62
12	0.89
16	1.58
20	2.47
22	3.00
25	3.87
28	4.8
32	6.8
36	8.0
40	9.9

**GLAZING**

Unless otherwise specified the glazing shall be patent, flattened sheet glass of Indian Make of the best quality, plain or ground. It shall weight 7.5 Kg / M<sup>2</sup> (24 ozs per sq.ft) upto a size of 60 cm. X 60 cm. and above that size 10 kg/m<sup>2</sup> (32 ozs. per Sq. Ft.). In case of non-actinic glass it shall be or Pilkington (India) make of thickness not less than 3 mm. Glazing shall be of quality approved by the Architects.

**PAINTS**

**Base :** These shall be of the best white lead, red lead, zinc white peroxide of iron or best approved make.

**Varnishes :**The oil shall be double boiled linseed oil and shall appear, when filled in a glass tube, pale and clear liquid it shall taste sweet with very little odour and shall dry quickly and firmly. It shall be of Godrej, Blundell and Spence or of other quality approved by the Architects.

Solvents shall be sprits of turpentine.

**Pigments :** These shall be of selected tints and approved make. Paints should conform to I. S. specifications.

**SECTION - C**

**CEMENT CONCRETE AND MORTAR**

### **LIME MORTAR**

Mortar shall be composed of one part of lime and two parts of sand, measured in wooden boxes. Lime and sand shall conform to relevant specifications given in section(B) The mortar shall be ground in a mechanical mortar mill with 200 turns. The mortar shall be kept moist and protected from sun, rain and dust.. Mortar of more than 7 days old shall not be used and before use the mortar shall be matured for 24 Hours. Lime mortar should conform to I. S .specification.

Surkhi shall be added without any extra as instructed by the Architects.

### **CEMENT CONCRETE FOR FOUNDATION WORKS**

All cement concrete for foundations shall have the mix as specified on the Drawings or as per written instructions of the Architects. If hand mixed, cement, sand and metal shall be accurately gauged using 10 % extra cement and thoroughly mixed on platform by being turned over atleast, twice dry and twice wet. Water shall be added gradually and no more shall be used than necessary to sufficiently wet the materials. It should be deposited gently in the trenches in horizontal layers of not more than 15cm. thick and gently levelled by suitable rammers. No more concrete shall be mixed than can be used within half an hour. After laying, the concrete shall be kept wet for the required curing period. Rate shall be per Cubic Meter.

NOTE- Hand mixing will only be allowed if the total quantity of work is very small. Concrete should conform to L. S. Specifications.

### **PROPORTIONS**

The various mixes of concrete, in the various parts of the works specified on the Drawings shall be accurately followed. The quantity of water used shall be the minimum required for work-ability and shall be varied as required to suit humidity and the moisture content of the aggregate and sand and to produce concrete having the specified slump.

### **DESIGN OF CONCRETE MIXES**

If the concreting is to be done either on volumetric basis or by weight batching, then in such cases the contractor has to submit the design mix along with the test results for such specified concrete mix, to the approval of the Architects. However, for normal curing such test results shall be submitted after a period of 7 days curing and 28 days curing, after casting of concrete cubes, as specified for design mix. Testing of concrete cubes shall be done in the Laboratories approved by the Architects. If a particular or specified design mix does not give satisfactory results, then the contractor has to make the variations in design mix in such a way that the design mix gives the desired results for that specified mix, subject to the approval of the Architects to such results. If design mix is to be used then it must be got approved by the Architects prior using the same in item.

### **MANIPULATION AND WORKMANSHIP**

Mixing – An approved mechanical batch mixer shall be used. The mixer and mixing platform shall be suitably protected from wind and rain. The aggregate and cement shall be first mixed dry and then after addition of water. Mixing shall be carried out until the concrete is of even colour and consistent throughout. The mixing of concrete of different mixes shall not be allowed to be carried out at one time, by the same mixer.

### **REINFORCED CONCRETE**

Aggregates for reinforced concrete shall be of stone metal sharp, clean and angular approved by the Architects, shingle will not be allowed. Cement concrete for reinforced concrete work: and/or plain cement concrete work, unless otherwise specified, shall consist of M-80, M-100, M-150, M-200, M-250, M-300 or such mixer as the Architect will direct from time to time

during construction work.

### **MIXING**

The aggregate and sand shall be washed 'or all dust and silt before using. The materials, shall be accurately measured and mixed as per approved design mix by the Consultants in a machine thoroughly or as on volumetric basis. The concrete shall have a specific slump. When proportions are specifically required by weight, they shall be mixed so.

### **CONSISTENCY**

The consistency of the concrete shall be determined at all times by means of a slump Cone test. The slump for concrete in the various members. shall not exceed the following

1]	Precast work		35 mm	slump
2)	Footings and Roads		30 mm	slump
3]	Columns		50 mm	slurqp:
4]	Walls (R.C.C.)		50 mm	slump
5]	Floor Slab		40 mm	slump
6]	Beams and Lintels		50 mm	slump

The slump tests shall be carried out as per I. S. 1. Care should be taken to ensure that a representative sample is taken.

### **STRENGTH**

Ordinary concrete mix on volumetric basis shall have the crushing strength as per IS-456 specifications. Ordinary concrete shall have minimum cement bags per cu.mtr. as given below.

NO.	Concrete Grade	Concrete Mix	Minimum Cement
1	PCC- M-75	1:4:8	3.20 Bags
2	PCC- M-100	1:3:6	4.05 Bags
3	RCC- M-150	1:2:4	5.90 Bags
4	RCC- M-200	1:1.1/2:3	6.90 Bags
5	RCC-M-250	1:1:2	8.50 Bags

## **SECTION D**

### **Target strength**

The target mean strength of specimen shall exceed the specified characteristic compressive strength by at least the "current margin".

- (i) The current margin for a concrete mix shall be determined by the Contractor and shall be taken as 1.64 times the standard deviation of sample test results taken from at least 40 separate batches of concrete of nominally similar proportions produced at site by the same plant under similar supervision over a period exceeding 5 days, but not exceeding 15 months.
- (ii) Where there is insufficient data to satisfy the above, the current margin for the initial design mix shall be taken as given in Table

TABLE

<b>Concrete Grade</b>	Current Margin (N/mm <sup>2</sup> )	Target Mean Strength (N/mm <sup>2</sup> )
M 15	10	25
M 20	10	30
M 25	11	36
M 30	12	42
M 35	12	47
M 40	12	52
M 45	13	58
M 50	13	63
M 55	14	69

### GRADES OF CONCRETE

The grades of concrete shall be designated by the characteristic strength as given in Table where the characteristic strength is defined as the strength of concrete below which not more than 5 percent of the test results are expected to fall.

Grade Designation	Specified characteristic compressive strength of 150 mm cubes at 28 days, in MPa
M 15	15
M 20	20
M 25	25
M 30	30
M 35	35
M 40	40
M 45	45
M 50	50
M 55	55

### MINIMUM CEMENT CONTENT AND MAXIMUM WATER CEMENT RATIO

Structural Member	Min. cement content for all exposure conditions (kg/Cu.m.)	Max. water cement ratio	
		Exposure conditions Normal	Severe
a) PCC members	360	0.45	0.45
b) RCC members	400	0.45	0.40
c) PSC members	400	0.40	0.40

### (A) MINIMUM STRENGTH OF CONCRETE

Member	Condition of Exposure	
	Moderate	Severe
a) PCC members	M 25	M 30
b) RCC members	M 35	M 40
c) PSC members	M 35	M 40

## **TEST**

The Contractor shall as and when directed by - the, Architects cast 15 cm ( 6" ) cubes of the concrete of approved design mix being used in the work and after curing shall get then tested. The cost of all testing shall be borne by the contractor. Forms for such test cubes shall be provided by the Contractor. The test results for such concrete cubes shall be submitted by contractor to Architects for Approval. Concrete mix, for shell roof shall be, controlled concrete M-200. The design. mix shall be .approved and tested from recognized Laboratory.

## **PLACING' OF CONCRETE**

Concrete shall be placed in mounds within 15 minutes of its being mixed with water. Mechanical vibrator shall be used while laying concrete for walls, slabs columns and means, footings .etc., for carrying up concrete, a mechanical power driven hoist shall be used, if so required by the Architects/ Engg.

## **FORM WORK [General]**

Shuttering shall be either of hard wooden 'planks 37 mm. thick or ply wood shuttering of 30 mm thickness or of steel plates stiffened by angle iron and all approved by Architects/Eng. All shuttering work shall be supported on battens, beams, props and wedges and properly cross braced together so as to make the form work sufficiently rigid, strong and stable to support the wet concrete and workers. It should yield on working and laying concrete. Beams for entering shall be carried and supported on the floor P. C. C. with double wedges underneath and supported at intervals with props.

Props shall be either T. W. bellies of sufficient strength and length or A. C. prop bellies props shall rest on double wedges placed over wooden sole planks of minimum 37 mm thickness. so as to Facilitate tightening and casing of the centering and shuttering work. .

Shuttering shall be kept clear of wall bearing or column bearing and made to rest on cross beams or battens. The shuttering shall have smooth and even surface and its joints shall be close tight and shall not permit leakage of cement. Slurry or water. Foam oil shall be applied to the inner faces of shuttering work which will be coming in contact with concrete work. To prevent adherence of concrete to shuttering materials.

All shuttering and centering work shall be removed as specified, all shuttering and centering work shall be removed slowly and care without any jerks or vibrations in such a that no part of concrete damaged and disturbed.

The contractor shall apply all necessary centering (false work) including planks. props, bracing, nails etc. and all necessary labour, plant and machinery etc. for centering centering of accurate size and shape for the various members is as also the labour and tools required for striking the same.

Forms shall be carefully examined to see that they are truly vertical and horizontal and the joints properly closed. When forms are to be reused they should be carefully examined before such reuse, properly aligned and have all open joints repaired and coated with a separator.

Centering and props for the various R. C. C. members shall be fixed in a workman like manner and shall be approved by the Architects or Engineers. They shall be of such sizes as Architects or Engineer think fit and proper. The centering shall be removed only after permission to that effect has been obtained (from the Architects or Engineers). Props shall not be less than 75 mm dia on top and shall be supported on wedges and planks. Planks shall not be less than 25 mm thick. The centering planks, runners and props shall of such dimension as are required by static calculations to be approved by the Architects or Engineers. For special type of work complete Drawings showing arrangement of centering shall be submitted, if demanded by the Architects or Engineers. .

The area of form work coming in contact with specified concrete work shall, only be measured for payments, if there is separate item for providing form work for concrete work in the Tender. The minimum period for keeping the centering in position for after laying material shall be as follows

Name of work	Centring	Watering
Slab in general	10 Days	Water Shall be compounded on slabs by making 1 m x 1 m ponds by bunds of cement mortar. Column shall be beams shall also be so covered to be kept wet for period 20 days.
Single slabs	Up to the completion of the storey above.	
Under side of beams and Lintel bottoms.	20 Days	
Vault roof slab flat slab	20 Days	
Side of the beams	02 Days	
Side of the column	02 Days	
Side of the Lintels	02 Days	
Coping sides	02 Days	
Shell Roof	As per the instruction given in drawings.	

**Cover to reinforcement: -**

Cover to reinforcement shall be in accordance with plate indicated on the R. C. C. Drawings and shall be maintained by the use of Precast cubes or cover blocks, of the size. The cover specified, or by mild steel bar spacers (equal in diameter to the cover Specified). These will not be measured and paid separately. .

**BENDING AND PLACING REINFORCEMENT**

The reinforcement bar shall be mild steel /tor steel as specified and shall confirm to relevant specifications given in section (B). It shall be accurately bent cold the shapes shown on the R. C. C. Drawings and all bends shall confirm to the details supplied. The reinforcement shall be built up exactly shown on the detailed Drawing and supported, so as to give correct cover. All inter sections bars shall be secured tightly with binding wires. Stirrups shall be secured tightly to the bars which they embrace and shall be kept from the faces of the concrete of the distance on the drawing.

The iron bars shall be free from scale or rust and shall be properly brushed and not painted. They shall be of diameters specified and bent to shapes as dimensioned and placed in position shown on plans & ends shall be hooked, the hook being eight times the diameters of the bars.

No splicing shall be allowed in short members. Where there is splicing, the bars shall be overlap for tension and for compression as per Drawings but excluding the hooked ends. They shall be bound together by binding wires. The reinforcement shall be approved and measured by the Consultant or their Engineer before concreting is started. The concrete shall be worked round the reinforcement and well vibrated. For consolidation of concrete in columns, beams, walls, & slabs, Mech. immersion vibrators shall be used. Where concrete is measured excluding steel only that steel actually in concrete shall be measured, but no allowance shall be made for wastage. Binding wire, laps or welding if any, steel used for maintaining reinforcement in position shall not be measured. Laps other than those shown on Drawings will not be measured & paid separately, but contractor has to provide the laps as shown in Drawing. The rate shall be inclusive of all.

### **COPING AND SILLS.**

Reinforced or plain cement concrete copings and sills shall be of the full thickness of the walls or will be as of specified thickness and, width and of specified concrete mix and finished and molded as per Design and drawings. They shall be reinforced as per Design. While casting the coping, the concrete shall be vibrated properly. Concrete mix shall be as specified on drawings.

### **LINTELS**

These shall be of dimensions as shown on the drawings and shall have the minimum bearing equal to the depth of the lintels on both sides of the opening, unless otherwise directed. The centering shall not be nailed to the door or window frames. The concrete mix be as specified on the Drawing.

### **BEAMS AND SLABS**

The cover below the lowest bar in beams shall be 25mm or the diameter of the thickest bar whichever is more and cover for bars in slab shall be 20 mm or as shown on Drawings. The work of filling in beams and slabs shall be completed in one operation as far as possible. If concreting is to be top permission shall be obtained from the Architects or Engineers and it shall be stopped at the center of the beam or wall as the case may be for the slabs in vertical plane and at right angles to the direction of beams, or as directed. After the forms are struck the surface shall be properly picked, & hacked immediately and a mixture of sand and cement dashed against the surface making it the surface true in one plane. The surface shall then be plastered with sand and cement mortar and finally finished smooth with a fine coating or neeru. The visible edges of beams and columns shall not be knife sharp but shall be finished as per Design and cornices. If any at the Junction of slabs and beam or walls shall also be finished as per Design. The surface then shall receive two coat of white wash.

### **MODE OF MEASUREMENT AND PAYMENT**

The rate for all R.C.C. members shall be exclusive of steel as reinforcement and finishing unless otherwise specified. Columns shall be measured in Cubic Meters of the actual work done between the slab. All beams shall be measured between the slabs. Beams being measured between columns. Slabs shall be measured in between columns. Slab shall be measured in Square Meter as of specified thickness and of specified mix or in M3 as shown on the Drawings.

Chajjas and canopies shall be measured in Sq. Meter clear of walls and of specified thickness and of specified concrete mix. If the fascia form or drop or pardi has been provided. It shall be measured in Square Meter separately and paid under pardi item. Lintels shall be measured in Cubic Meters for actual length provided. The sizes of all R.C.C. members shall be measured exclusive of finishing and as per the dimensions on Drawings.

Steel reinforcement bars shall be measured and shall be paid as the weight in Kg. of the actual quantity of steel reinforcement placed in structure arrived at by measuring the length of the bars multiplied by the standard weight per unit length for particular diameter of bar given in relevant part of Section (B).

In case of deformed bars the weight per unit length for bar of specified diameter will be as shown in the manufactured catalogue. This shall include quantity of laps, hooks and bends. The cost of wire used for tying reinforcement steel chairs and angles etc. shall be deemed to be included in the rate of the item of reinforcement and shall not be paid for separately.

**SECTION E**  
**BRICK MASONRY**

**CEMENT MORTAR**

Cement mortar shall be normally composed of one parts of cement to six parts of sand unless otherwise specified the ingredients shall be accurately gauged by measured and shall be well and evenly mixed together dry on a platform, care being taken not to add more water than is required. No mortar that has began to set shall be used.

Where a different preparation is specified that shall be the proportion used in that particular place. Contractor at his own expenses shall be required to test the cement mortar, if found necessary and the test result shall be submitted to the Architects or Engineers for approval.

**BRICK WORK**

Brick work is to be carried out with all necessary setbacks projections, cuttings footings etc. which are shown on Drawings and strict conformity with them. All uneven irregular and bad brick work shall be demolished if deemed necessary by the Architect or Engineers and rebuilt at contractor's risk and cost.

All joint of brick work to be plastered or pointed, shall be properly raked out to a depth of 12 mm as the work proceeds. In no case mortar which has set shall be removed from joints by hammering, chiseling or in a manner as to cause no damage to the brick, but shall be raked out with a suitable metal tool before the mortar sets.

Every brick shall be thoroughly soaked in water before using, till bubbles cease to come up. No broken bricks shall be used except as closers. The courses shall be truly horizontal and the work strictly in plumb, joints shall be broken vertically and they shall not exceed 12 mm in thickness. The brick work shall not be raised by more than 10 courses per day. Tables shall be formed at every eleventh course and kept full of water. The bricks shall be laid in English bond.

In bricks arches or other circular work, the bricks shall be shaped to slope joints radiating correctly to the centre, from front to back of walls and not more than 12 mm. thick. The face bricks shall be of uniform colour and have sharp arise. The work shall be well watered three times a day for 10 days and afterwards twice a day 21 days. The brick to be used in work shall conform to I.S. specifications. Good quality locally available bricks can also be used if approved by the Architects or Engineers. The work shall be protected during the rains as directed.

**MODE OF MEASUREMENT AND PAYMENT**

The rate of brick work shall be inclusive of all necessary scaffolding, centering, watering and cutting of bricks for circular works, arches, corbels, projections etc. The measurement of work shall be the produce of length, height and thickness. Deductions shall be made for all openings, lintels, beams and columns occupying the full thickness of the wall. The work shall be paid per unit of one Cubic Meter or square Metre as given in schedule of quantities.

**BRICK PARTITIONS (Reinforced)**

Brick partitions shall be of 1/2 brick width or brick on edge when so specified. Partitions of 1/2 brick thickness shall have one R. C. C. M-150 bonding layer, 2 layers high and of full width. It shall be reinforced with 4 numbers of 6 mm. Dia. M. S bars with stirrups of 6 MM Dia. M. S. bars at 200 mm c/c, Cement mortar used for masonry will be 1:6 or as specified and when there are doors in such partition the bend will be on top of such door.

For bricks on edge partitions separate specifications will be indicated in the job description in schedule of quantities. 1/2" brick partitions will be measured in Sq. Meter without plaster. No allowance shall be made for concrete band or shuttering, Reinforcement will be measured and paid separately, under M. S. reinforcement item for R. C. C. pardi.

**FAIRFACE**

All 115 mm, 125 mm, 350mm and 450 mm walls will be built fair faced on the side only. .All walls of greater thickness shall be built exception with fair face to both sides.

## **SECTION -F** **PLASTER**

### **CEMENT PLASTER (Neeru)**

Cement shall be thoroughly mixed dry with sand in the proportion of one to four or as specified. Water shall then be added gradually to make the mixture homogeneous. No more cement shall be mixed than, that can be used within half an hour. The joints between the stones or bricks will be raked out to a depth of 12 mm and the surface shall be thoroughly watered and the mixture of sand and cement applied evenly on all surfaces to be plastered. The surface shall be finished off with a thin layer of neeru. The plaster work shall be kept thoroughly wet for a period of seven days. The item shall be paid per Sq. Metre. Local sand, if approved by the Architect or Engineer can also be used for plaster work.

The rate shall include jambs, coves at the junction of walls, ceiling and beams and all corners. Deductions for openings, doors, windows, etc. shall be made as per I.S. specifications.

### **SAND FACED CEMENT PLASTER**

All surfaces shall be cleaned or all dust and dirt and the brick work thoroughly watered. The backing coat shall be 12 mm, thick of cement plaster in the ratio of 1:4 and a finishing coat 6 mm thick consisting of grey cement and sand shall be applied on the surface. After curing the, this first coat sufficiently, a finishing coat 6 mm. thick consisting of grey cement and sand of approved quality in c.m. mix (1:3) shall be applied and finished to desired texture local sand if approved by the Architects or Engineers can also be used for sand faced cement plaster. The average plaster thickness shall be 16 mm to 20 mm .

**The mode of measurement** shall be the same as per cement plaster, and deductions shall be made as per I. S. specifications.

### **CEMENT POINTING**

Mortar shall raked out of the joint to a depth of 12 mm. Dust shall be brushed out of the joints and the wall well wetted. Pointing shall be done with cement and sand mix in equal proportion or as per proportion specified. The joints of the pointed work shall be neatly finished as directed and shall be kept wet till the cementing material has set and become hard. Curing shall continue for a minimum period of seven days.

The item will be paid per Square Metre. Deductions shall be made as per I. S. specifications. Local sand can be used for this work if approved by the Architect or Engineer.

### **ROUGH CAST CEMENT PLASTER**

All joints shall be raked out as for cement plaster. Cement shall be thoroughly mixed dry with sand and gravel to pass through 6 mm. (1/4)mesh but not through 1.5 mm. (1/16") in the proportion of 1 part of cement, 2 parts of sand and 1 part of gravel. Water shall be gradually added to make the mixture homogeneous. No more mixture shall be prepared that what cement be used within half an hour. The mixture shall be dashed against the surface to a thickness of 20 mm. and finished level. The mode of measurement shall be the same as for cement plaster, curing shall continue for a minimum period of seven days. Deductions shall be made as per I. S. specifications. Average thickness of plaster work shall be 20 mm.

### **TERRACO FINISHING (Spray Plaster)**

The work of finishing to interior building surfaces shall be done by Spray Plaster of Terraco. It is a ready made mix plaster which replaces neeru finishing, putty primer and also reduces paint consumption. If the Item of Terraco finishing included in the schedule of quantities, following procedure shall be adopted.

The spray plaster should be applied one day surfaces only. Before spray plastering, the work of common type of plastering should be done without neeru and left the surfaces for complete drying. When surfaces where spray plastering is to be applied become dry, then only the

spray plaster shall be applied on cement plaster likewise the application before painting the wall. Before applying the spray plaster, the dust, dirt and foreign matter should be brushed away. So also any ridges and form oil should be removed suitably. The work of spray plastering shall be done in two coats. However the work of finishing should be done up to the satisfaction of the Architects or Engineers.

### **FLOORING**

Providing and laying cement concrete flooring 50mm thick with M20 cement concrete laid to proper level and slope in alternate bays including compaction, filling joints, marking lines to give the appearance of tiles of 30cm x 30cm or other size laid diagonally / square etc. finishing smooth (with extra cement) in any colour as directed and curing etc. complete. With Natural Sand

### **SECTION-H**

#### **M.S. DOORS AND WINDOWS**

Steel doors and windows shall be with standard sections and sizes, as mentioned on the Drawings. They shall be of approved make. They shall comply with I.S.1038: 1959.

- i. Windows and ventilators shall be of rolled mild steel sections 25mm wide (1.5KP/M) and Doors of 35 m.m. wide sections (Approx, 2.55Kg/M) or as specified in the Drawings.
- ii. The frames shall be in one plane; joints shall be mitered and welded on butt welding machines. Glazing bars shall be tennoned and riveted. The intersection of T bars should have Fenestre joints .
- iii. The sections shall be given anti-rust treatment (by picking) before shop coat of paint is applied. Final coats of paints shall be specified. Glass panels to Doors and Windows shall be fixed by means of teak and bends. putty, glazing to skylight shall be fixed as per manufacturer specifications. These shall be measured from outside to outside to outside and shall be paid per Sq. Mtr. The rate shall include storing, handing and fixing in position.
- iv. Providing and fixing solid core flush door shutter in single leaf 32 mm thick decorative type of exterior grade as per detailed drawings approved face veneers 3 mm thick on both faces or as directed, all necessary beads, mouldings and lipping, wrought iron hold fasts, chromium plated fixtures and fastenings, with brass mortise lock, chromium plated handles on both sides, and finishing with French Polish etc. complete.
- v. Providing and fixing 30mm thick SOLID PANEL PVC INTERNAL DOOR SHUTTER consisting of frame made out of M.S. tubes of 19 gauge thickness and size of 40mm x 20mm for stiles ,top, lock and bottom rails. M.S. frame shall have a coat of steel primers of approved make and manufacture. M.S. frame shall be covered with 5mm thick heat molded PVC channel of size 30 x 100mm forming stiles, and 5mm thick, 125mm wide PVC sheets for top rail, lock rail and bottom rail on either side, and 15mm (5mm x 3) thick, 20mm wide cross PVC sheet as gap insert for top rail and bottom rail. Paneling of 10 mm thick prelam PVC sheet to be fitted in the M.S. frame welded / sealed to the stiles and rails with 30mm wide x 5mm thick PVC sheet beading on either side, and joined together with solvent cement adhesive etc. An additional 5mm thick PVC strip of 20mm width is to be stuck on the interior side of

the C Channel using PVC solvent cement adhesive. including stainless steel fixtures and fastening Complete as per direction of Engineer incharge, manufacturer's specification and drawing.

- vi. Providing and fixing in position. (as per I.S.1868 / 1982) Aluminium sliding window of two tracks with rectangular pipe having overall dimension 63.50 x 38.10 x 1.02 mm at weight 0.547 kg/Rmt. and window frame bottom track section 61.85 x 31.75 x 1.20 mm at weight 0.695 kg/Rmt. Top and side track section 61.85 x 31.75 x 1.30 mm at weight 0.659 kg/Rmt. The shutter should be of bearing bottom 40 x 18 x 1.25 mm at weight 0.417 kg/Rmt. Inter locking section 40 x 18 x 1.10 mm at weight 0.469 kg/Rmt. And handle section 40 x 18 x 1.25 mm at weight 0.417 kg/Rmt. and top section 40 x 18 x 1.25 mm at weight 0.417 kg/Rmt. As per detailed drawings and as directed by Engineer in charge with all necessary Aluminium sections fixtures and fastenings such as roller bearing in nylon casting and self locking catch fitted in vertical section of shutter including 5 mm thick plain glass with all required screws and nuts etc, complete. With powder coating without box

### **WROUGH IRON AND STEEL WORK**

Providing and fixing mild steel grill work for windows, ventilators etc. 20 kg/sqm as per drawing including fixtures, necessary welding and painting with one coats of anticorrosive paint and two coats of oil painting complete.

All W. I. and steelwork shall comply with specification and design. The manufacturer shall be as approved by the architects or Engineers.

Grill. work, and grill gates shall be as per the Architect's or Engineers design.

Collapsible gates will be of mid bars type, made out of 20mm channel and will be top hung with ball bearings and will have locking arrangements as specified.

Roller shutter will be of approved make, the rolling slates, being in one place, they shall be provided with a cylindrical hood at top to enclose the shutter when it is opened.

All the W.I. and steelwork mentioned in this section should receive a shop coat of red lead paint before erection on site. In the case of grill work, grill gates, collapsible gates, or welded mesh grill and failing, the work shall, be measured in square meter for supply and fixing and shall be paid per Square Meter including painting, Fitting etc. Rolling shutter shall be measured as per opening provided in masonry work for fixing the same.

Inthe case of steelwork in trusses, purlins and other fabricated work, the work shall be measured by weight of actual work done and shall be paid per Tonne. Detailed specifications specified on Drawings or as per direction from Architects or Engineers. The rates shall be inclusive at one coat of primary red oxide paint. .

### **SECTION – I PAINTING**

#### **PAINTING:-**

Where the term paint or painting or to be painted or Colour wash or white wash etc. is used in specification or in bill of quantities. It includes the scraping, cleaning and painting or color washing or distempering or white wash as the case may be all to be the satisfaction of the Engineers or Architectures.

#### **Priming:-**

Neither any shop quote of paint here in specified for any priming quote shall be considered as a quote of paint for the purpose of these specification. Putty shall be composed of the best quality of whiting mixed with double boiled linseed oil properly kneaded to workable consistency

### **Oil Paint:**

Surfaces to be painted shall be dry free from dust and dirt and rubbed smooth by means of sand paper, or pumice stone to the satisfaction of the Architect or Engineers the paint shall be mixed in proper proportion as per the manufacturer's specification and driers and pigments shall be carefully added as and when required alternatively paints of approved quality and shade may be used.

The primary coat shall be of white zinc and double boiled oil only and shall be applied evenly after the primary coat is applied and perfectly dried all holes, cracks etc., shall be filled in with putty and the surface is prepared then a second coat of paint with the addition of the pigment shall be carefully applied as and when required. When the work is to be varnished the varnish shall be best varnish, mixed with turpentine if required and evenly applied in required number of coats the rate shall be per sq. Meter and deduction shall be as per I.S. Specification.

### **OIL BOUND DISTEMPER**

All plaster shall be thoroughly cleaned and shall receive three coats as specified below First, a coat of prime shall be applied, after the primary coat, of white lime wash is properly scraped off, the second. And the third coat shall be applied with oil bound distemper of approved tint and quality, mixed with water as per Manufacturer's specifications. If after these operations, the work is not done to the satisfaction of the Architects or Engineers then one more coat shall be applied without extra cost till the work is executed to the satisfaction of the Arch./Eng.

### **DRY DISTEMPER WASH/COLOR WASH**

All plastered surfaces shall be thoroughly cleaned and shall receive coats of dry distemper color wash at first White lime wash shall be evenly applied and scraped off when dry, A first coat, of prime size shall then be applied. Second and third coats shall be of dry distemper or color wash of approved quality in mixed with water as per manufacturer's specifications. In case the work is not done to the satisfaction of the Architects or Engineers then one more coat shall be applied without extra cost till the work is executed to the satisfaction of the Arch./Eng. All the painting work shall be measured in Square Meter for actual work done including all soffits, jambs, sills, walls, plastering surfaces etc. and shall be paid per Sq. M., All deductions shall be per I.S. Specification.

### **FRENCH POLISH**

The Woodwork shall be first be cleaned and scraped thoroughly with glass paper, It will then be painted with a filter composed of whitening and methylated spirit and again cleaned with glass paper a thin coat of French polish shall be applied until the finishing is done to the satisfaction of the Architects or engineers.

### **INTERIOR PAINT**

Providing and applying plastic emulsion paint of approved quality, colour and shade to old and new surfaces in two coats including scaffolding, preparing the surface. (excluding the primer coat) etc. complete.

### **EXTERIOR PAINT**

Providing and applying two coats of exterior weather shield paint of approved manufacture and of approved colour to the plastered surfaces including cleaning, preparing the plaster surface, applying primer coat, scaffolding if necessary, and watering the surface for two days etc complete.

### **MODE OF MEASUREMENT AND PAYMENT.**

The oil paints and French and wax polish work will be measured in sq. Meter from outside of the framing as follows

- a) Fully glazed partition window and door : Sq. area of one face only.
- b) Half paneled and half glazed. : 1. 1/2 times the area of one face.
- c) Fully paneled : twice the area of one face.

Note- The work mentioned in this section shall be measured separately in case it is distinctly so specified in scheduled of quantities.

### **SECTION-K**

#### **DRAINAGE, SEWAGE, WATER SUPPLY AND STORM WATER DRAINS.**

'The contractor will be wholly, responsible' for any, extra excavation done by him below the required levels as directed. Extra width of excavation will be required at the place of joints, for the facility of work of caulking the joints. This extra excavation in width and depth will not be paid in any item.

Bailing out of water should be properly carried out by the contractor at his own cost Electric, diesel pumps or manual labor can be used for the purpose.

The final bed of the foundation, after the excavation is completed shall be got approved by the contractor from the Architect or Engineer before the concrete is laid.

#### **PROVIDING AND LAYING C. I. PIPES**

- a) All the pipes to be taken into use shall be cleaned and brushed clear off rust and painted at both spigot and socket ends.
- b) Before the pipes are lowered and laid in trenches the contractor shall see that the bedding is plain of the surface is brought to uniform grade and leveled with the help of cross sight rails and boning staff and approved in advance by at least 3 days by the Architects or Engineers
- c) The contractor shall provide and fix and maintain cross sight rails and boning staff wherever required until' the time of completion without any extra claim for cost etc. and which shall be considered inclusive in the rates for excavation etc.
- d) Temporary bench marks shall be provided by the contractor if called upon at a minimum distance of every 30 Mt. without any claim for extra cost. The bench marks. Shall be either of stone masonry Or mass concrete.
- e) Materials used for jointing such as hemp etc. shall be got approved in advance from the Architect or Engineer.
- f) No jointing operations shall be started unless tile grade and levels are approved by the Architects or Engineers
- g) Under no circumstances the C. 1. Pipes and other water mains will be laid on rock bedding without murum cushioning.
- h) The murum cushioning of a depth of 1/3rd the dia Mtr. or 15 cm. 'whichever is greater as Specified shall always be provided in all formation with the rate of laying pipe line unless as item for murum bedding is provided for separately in the tender.
- i) All obstacles such as electric wires, water and sewer main, manholes, natural ,drainage Culverts, storm water drain etc. coming in the way shall carefully be looked after and any damage be prevented to the same. Any work of removing, repairing and re-doing such structures Or obstacles in the process of laying pipe lines etc. should be carried by the Contractor without any claim for extra cost unless previously approved by the Architects or Engineers.

- j) The contractor shall allow for wastage breakage in cost pipes at his own cost whenever the item is for providing and laying pipe lines.
- k) Pipes shall be laid in reasonably dry trenches and under no circumstance on slushy murum bedding.
- l) The contractor shall make own arrangements for the obtaining permission for storing and Stacking of pipes etc., on the road from the land owners whether it belongs to any other Govt. Department or Municipal or private land owner.

**SPECIFICATION FOR PROVIDING AND LAYING AND JOINTING A C/P V.C. PIPES WITH COUPLERS/C.I.D. JOINTS/SOLVENT CEMENT GENERAL**

The item pertains to providing and laying A.C./P. V.C; pipes of all classes of specified diameter with CID, joint/solvent cement as specified in the item for water supply including collar, socketed bends, socketed tee, socket cross, socket and spigot, tapers cap, plug, duck foot bends, excavation, laying pipes and back filing.

This item shall be subject to the general specification.

**MATERIALS**

The diameter of the A.C./P.V.C. pipes specified in the wording of the item shall be the diameter of the bore of the pipes and the pipes shall conform to I. S. 1536-1967 or I. S. 1537 -1960. All the fittings (specials) shall conform to L. S. 1538 -1960. The pipes and fittings shall have sockets and or spigot as shown in the Drawings, specified in the special provisions or necessary for the work.

**EXCAVATION**

Before starting excavation of the trench, sight rails shall be fixed on the alignment of the pipe line at an interval of 30 mtr. and at every change of grade and direction at a definite and as far as practicable uniform height above the invert of the pipes the centre line being clearly marked on each rail.

The width of the trench shall be at least 30 cms. (about 12") wider than the socket of the pipe so as to allow room for ramming the refilled material under and at the sides of the pipe.

The depth shall be such that the pipes shall have a clear cover of at least 75 cm. The trench shall be excavated through all strata met with. When it is necessary and ordered by the consultant in writing, the sides shall be shored or sloped, otherwise, they shall be as vertical as possible. The rate shall include shoring and provision of slopes. In case rock is met with, it shall be excavated 15 cm. more than the required depth for providing cushioning by chiseling and line drilling unless blasting is permitted in writing by the Consultant. Special precautions shall have to be taken in blasting as ordered by the Consultants. Dewatering of the trench, if required, shall be done without separate claims. The bed shall be even and to the correct grade and line in all cases.

The trench shall be barricaded and warning boards fixed. Red lights shall be, hung at night time at sufficiently close intervals to indicate the danger and a Chowkidar employed to see that the lights are properly burning. The contractor shall be solely responsible for any accidents due to any default in barricading. Sign posting or red lights and shall bear the consequences.

In case of excavation across a road, permission of road authorities shall be obtained for the excavation of the road surface which shall be made good and restored to the original condition by the contractor at his own cost. At all road crossings, the trench shall be excavated only for half the width of the road and pipe laid. The other half shall be excavated only after backfilling over the laid pipe and marking it suitable for the traffic. At all road crossing, the pipes shall be laid below the crust of the road.

All pipes, cables, service lines etc., met with during, the excavation shall be carefully pro-

tected and supported. Any damage done shall be made good by the contractor at his own cost.

### **LAYING**

The pipes shall be laid out along the side of the trench, each pipe in its proper Position for laying with an extra pipe after every 20 to allow for cutting if necessary whether the trench crosses a road or place where such distribution is in admissible the pipes shall be stacked in heaps at each end, sufficient to fill in the length. Small pipes below 100 mm diameter may be stacked in heaps at every 30 m.

As far as possible, pipes shall be laid straight in rising or falling gradient. It should be possible to empty the pipe readily and completely.

In case of rock bed, murum bedding of 15 cm. shall be provided before laying pipe. The C.I.D Joints/Coupler joints shall be made and paid separately. The P. V,C, pipes shall be jointed with solvent cement and shall be paid under this item only. At the end of each day's work, the open end shall be suitably plugged.

### **BACK FILLING**

After making the joints, and testing the pipe line to ensure leak proof joints, the trench shall be refilled in layer. And manually rammed. The excavated stuff shall be used in filling, .such that the filling .shall correspond to the original natural layers. The fillings shall be kept raised by about 8 cm. per meter of the depth of trench for subsequent settlement. In the case of trench in rock, 4 bedding and cushioning 'of murum shall be provided on the sides and top of the 'Pipe; Any surplus excavated stuff' shall be disposed off satisfactory without causing nuisance.

### **ITEM TO INCLUDE**

- 1) Supply of A.C/P. V. C. pipes of specified type nod diameter and fittings such as socket, collar, socketed bends, socketed cross, socket and spigot layers, Clip and solvent cement for jointing of P. V. C. pipes.
- 2) Excavating trench including laying. out, setting up sight rails, remaining soft bed, providing and ramming murum cushioning in rock excavation, shoring sloping. dewatering if required. Protecting and refilling trench, after laying the 'pipe and making good excavated road surface.
- 3) Laying pipes including cutting where necessary and waste.
- 4) All necessary labor, materials and use of tools and equipment to complete the item satisfactory.

### **MODE OF MEASUREMENT AND PAYMENT**

The contract rate shall be for One meter of pipe laid including all fitting. Making up C.I.D. /coupler joint paid for separately. For P. V. C. pipes the item includes jointing also cutting and waste will not be paid for separately The length shall be measured net on the straight and curves along the centre line over the pipes and fittings correct up to one item.

## **ROOFING**

### **PROFILE SHEET**

Providing and fixing colour coated Zinalume ( R ) AZ150 ( min 150 gms/sq.mt. total on each side ) profiled sheets for roofing. The feed material is manufactured out of nominal 0.45mm Base Metal Thickness ( BMT ) (0.5 mm TCT ), Hi-strength steel with min.550 MPa yield strength, metallic hot dip coated with Aluminium-Zinc alloy (55% aluminium 43.4% zinc 1.6% silicon) with COLORBOND ( R ) steel quality super durable polyester paint coat ( with inorganic pigment). The paint shall have a total coating thickness of nominal 35 um, comprising of nominal 25 um exterior coat on top surface and nominal 10 um reverse coat on back surface. Profile sheet shall have nom. 950-1050 mm effective cover width and

nominal 25-30 mm deep ribs with subtle square fluting in the five pan at nominal 180-250 mm center-to-center. The end rib shall be designed for anti-capillary groove. and return leg. The feed material should have coil manufacturers product details marked at a regular interval. Including fasteners with min. fastened with min. 25 um Zinc-Tin alloy coated, Hex head, self-drilling screw etc. complete. (weight of profile 4.52 Kilogram/Square Metre)  
Providing and fixing valley gutter of 24 B.W.G. (0.63 mm) thick G.I. sheet 120 cm wide with 20 mm thick teak wood planking underneath coal tarring etc. complete.

### **DRAINAGE SPECIFICATION**

#### **STONEWARE OR HUME PIPE DRAIN LINE**

The S.W. or Hume pipes should be of approved design and of standard quality.

The joints to be made (spigot and socket or collar as the case may be) by dashing 2 or 3 strands of tarred gasket which should be filled afterwards with neat C. M. (112) and wiped out clean. The line should be perfectly straight and true to required grade or slope  
Before filling the excavated trenches, the pipe line should be tested for standard hydraulic test to the entire satisfaction of the Architects or Engineers. The item includes laying the pipe line on rammed and consolidated foundations jointing, testing and refilling the excavated trenches after completion of work. The trench is to be filled with hard murum for 30 mm. above the pipes and the rest should be filled with ordinary excavated stuff. The trenches to be filled in 2 layers. If any leakage is found It should be immediately removed.

#### **B.B MASONRY CHAMBERS**

The chamber shall be excavated to the depth required for the foundation below the invert of the drain pipe, at the site of the pit and shall be of required size Foundation shall be (1:3:6) C,C wall to be in 25cm brick work in C.M. (1:6) walls and bottom to be internally plastered with a 20 mm thick plaster thickness in cement and sand (1:3) finished with neat cement, At the bottom of each pit a channel of full width and depth of pipe drain is to be constructed of cement concrete plastered with 25 mm coating of cement and sand (1:3) similar curved channels are to be constructed of cement concrete plastered with 2.54 coating of cement and sand (1:3). Similar curved channels are to be constructed in the pits to be given gradient of 1 in 30. All cement work to be watered for 15 days after completion.

The rate shall be including excavating, base concreting B.B. Masonry inside plastering, fixing of gully trap fixing of CI frame and cover of concrete cover fixing, benching etc. comp l.- etc The frame and cover should be got approved before fixing..

#### **S. W. SEWER TRAP CHAMBER**

Specifications same as per above Item. The item includes providing and fixing sewer trap of size specification specified in the memorandum with CI frame and cover of required size of precast RCC cover as specified The cover shall be fixed neatly on the top of chamber in CM (1:6) The cover shall be of required weight and size either round or rectangular as required CI steps shall be provided in the sewer tripe chamber.

#### **CI VENT PIPE**

Providing and fixing 10 CM dia GI Pipe ventilator with screen cover of mosquito wire gauge, with burnet brick masonry in cement mortar in proportion 1:6 Ventilator includes the construction of cement concrete foundation and pillar of 45 \*45\*60 cm as per instructions The pillar should be plastered on all side and should be watered for 10 days 10 cm dia GI pipe of 4.5 Meters heights should be fitted in the pillar with mosquito gauge at the top end.

#### **PROVIDING AND LAYING DRAINAGE LINES**

- 1) The sewer shall be to the alignment and gradient shown on the places and sections and also actually on site. The socket end. of pipes shall always face upstream of sewage flow.

- 2) The sewer shall run in perfectly straight lines between manholes as shown on plans.
- 3) The alignment and gradient of each pipe shall be checked by means of boning rod and sight rail and of the invert will be tested by means of straight edge regularly.
- 4) The pipes before being laid shall be thoroughly cleaned, specially at the inside of the pipes.
- 5) No extra rate will be paid for cutting pipes to make up and adjust length in alignment between manholes.
- 6) After sufficient time has been allowed for the joints. to set, before filling the trench, the joints of pipes must be proved water tight by filling the pipes with water to the level of 2 meters above the top of the highest pipe in the length to be tested heading the water up for a period of testing. No portion of pipe shall under any circumstances be covered up until inspected and passed by the Architect or Engineer.
- 7) The water test is made inserting plug at the lower end of each length and a right angled bend at the. top brought into position and made tight with clay. The air bubbles having escaped after the first filling, water is again added to completely fill the pipe. If the water level does not fall more than 13 mm. in a length of 9 m. the joints may be regarded as satisfactory. All testing apparatus. are to be brought and fixed by the contractor at his costs.

**PROVIDING AND FIXING R.C.C SADDLE BLOCKS**

R.C.C. Saddle block of size (100 X 60cm.) clear and 1.5 Cm. thickness and these must be fixed in position and fixed in base in C. M. (1:6) Rate to include providing foundation for these blocks, curing etc. complete. The blocks will have to be cast on site as approved by the Architects or Engineers. The curing tank must be constructed and blocks cured for 21 days. The reinforcement will be 12 m.m dia at 15 cm. c/c both ways.

**PROVIDING AND FIXING STEEL BARS**

Steel bars should be provided and fixed in position according. as required and as per instructions. The payment will be done on M.T. basis.

**Quality Control**

1. All materials to be used, all methods adopted and all works performed shall be strictly in accordance with the requirements of these Specifications. The Contractor shall set up a field laboratory at locations approved by the Engineer and equip the same with adequate equipment and personnel in order to carry out all required tests and Quality Control work as per Specifications and/or as directed by the Engineer. The internal layout of the laboratory shall be as per Clause 121 and/or as directed by the Engineer. The list of equipment and the facilities to be provided shall be got approved from the Engineer in advance.
2. The Contractor's laboratory should be manned by a qualified Material Engineer/Civil Engineer assisted by experienced technicians, and the set-up should be got approved by the Engineer.
3. The Contractor shall carry out quality control tests on the materials and work to the frequency stipulated in subsequent paragraphs. In the absence of clear indications about method and or frequency of tests for any item, the instructions of the Engineer shall be followed.
4. For satisfying himself about the quality of the materials and work, quality control tests will also be conducted by the Engineer (by himself, by his Quality Control Units or by any other agencies deemed fit by him), generally to the frequency set forth herein under. Additional tests may also be conducted where, in the opinion of the Engineer, need for such tests exists.
5. The Contractor shall provide necessary co-operation and assistance in obtaining the

samples for tests and carrying out the field tests as required by the Engineer from time to time. This may include provision of labour, attendants, assistance in packing and dispatching and any other assistance considered necessary in connection with the tests.

6. For the work of embankment, subgrade and pavement, construction of subsequent layer of same or other material over the finished layer shall be done after obtaining permission from the Engineer. Similar permission from the Engineer shall be obtained in respect of all other items of works prior to proceeding with the next stage of construction.

7. The Contractor shall carry out modifications in the procedure of work, if found necessary, as directed by the Engineer during inspection. Works falling short of quality shall be rectified/redone by the Contractor at his own cost, and defective work shall also be removed from the site of works by the Contractor at his own cost.

8. The cost of laboratory building including services, essential supplies like water, electricity, sanitary services and their maintenance and cost of all equipment, tools, materials, labour and incidentals to perform tests and other operations of quality control according to the Specification requirements shall be deemed to be incidental to the work and no extra payment shall be made for the same. If, however, there is a separate item in the Bill of Quantities for setting up of a laboratory and installing testing equipment, such work shall be paid for separately.

9. For testing of samples of soils/soil mixes, granular materials, and mixes, bituminous materials and mixes, aggregates, cores etc., samples in the required quantity and form shall be supplied to the Engineer by the Contractor at his own cost.

10. For cement, bitumen, mild steel, and similar other materials where essential tests are to be carried out at the manufacturer's plants or at laboratories other than the site laboratory, the cost of samples, sampling, testing and furnishing of test certificates shall be borne by the Contractor. He shall also furnish the test certificates to the Engineer.

11. For testing of cement, concrete at site during construction, arrangements for supply of samples, sampling, testing and supply of test results shall be made by the Contractor as per the frequency and number of tests specified in the Handbook of Quality Control for Construction of Roads and Runways (IRC : SP : 11) and relevant IS Codes or relevant clauses of these Specifications, the cost of which shall be borne by the Contractor.

12. The method of sampling and testing of materials shall be as required by the "Handbook of Quality Control for Construction of Roads and Runways" (IRC : SP : 11), and these MOST Specifications. Where they are contradicting, the provision in these Specifications shall be followed. Where they are silent, sound engineering practices shall be adopted. The sampling and testing procedure to be used shall be as approved by the Engineer and his decision shall be final and binding on the Contractor.

13. The materials for embankment construction shall be got approved from the Engineer. The responsibility for arranging and obtaining the land for borrowing or exploitation in any other way shall rest with the Contractor who shall ensure smooth and uninterrupted supply of materials in the required quantity during the construction period.

Similarly, the supply of aggregates for construction of road pavement shall be from quarries approved by the Engineer. Responsibility for arranging uninterrupted supply of materials from the source shall be that of the Contractor.

#### **14. Defective Materials**

All materials which the Engineer/his representative has determined as not conforming to the requirements of the Contract shall be rejected whether in place or not; they shall be removed immediately from the site as directed. Materials, which have been subsequently corrected, shall not be used in the work unless approval is accorded in writing by the

Engineer. Upon failure of the Contractor to comply with any order of the Engineer/his representative, given under this Clause, the Engineer/his representative shall have authority to cause the removal of rejected material and to deduct the removal cost thereof from any payments due to the Contractor.

## LIST OF APPROVED MAKES

The Engineer-in-charge is at liberty to select any of the brands indicated below. The Contractor has to obtain prior approval from Engineer-in-charge before placing order for any specific material not listed below.

All material should confirm to relevant standards and codes of BIS and shall have ISI mark. In the case of items for which approved make / vendor is not given below, the contractor shall with the prior approval of the Engineer-In- charge procure the same of the first quality and satisfy the Engineer-In-charge before use in the works. In case of contradiction between the approved makes /vendors specified below and mentioned in the Specifications / Bill of quantities, the decision of the Engineer-incharge shall be final and binding on the Contractor.

Sr No.	Material	Approved Manufacturers
1	Reinforced Steel	TATA, GOAL, KALIKA, RAJURI OR EQUIVALENET
2	Structural steel	TATA, GD MALHOTRA, GOAL, APOLLO OR EQUIVALENET
3	Roof Sheet	JSW, TATA, ESSAR OR EQUIVALENET

## Annexure-3

### ESHS Compliance Plan

After finalization of a contractor, it is mandatory for the contractor to prepare and implement the Environment and Social Management Plan (ESMP). For Health and Safety of workers and community, the plan entailing the below aspects need to be prepared and implemented;

#### A) Social Management Plan:

1. **In case of labour influx**, (if labours are not available locally and to be outsourced from outside district/region/state) the basic residence facility (setting up of camps, provision of residence with all basic amenities) need to be provided. Due to labour influx, there may be risk of communicable disease, gender based violence among workers and community. Hence the plan to avoid/mitigate these factors also need to be prepared and implemented.
2. **At workplace** : The following provisions/measures need to be complied at workplace
  - The provision of clean drinking water, health and hygiene facilities, separate washrooms for male & female, first aid kit, child crèches for women etc.
  - Mechanism to restrict sexual harassment of women and child at construction site, mechanism to prevent child labour and bonded labour, etc.
  - For safety of workers, Safety equipment like provision of personal protection equipment (PPE) for workers, such as safety boots, helmets, masks, gloves, protective clothing, goggles, full-face eye shields, and ear protection, firefighting equipment need to be provided.
3. **Community Safety Measure:** For avoiding the accidents due to increase in traffic at local level, the plan regarding road transport and road traffic management i.e. to provide signs at strategic locations of the roads, install and maintain a display board at each important road intersection on the roads to be used during construction, display boards about information regarding construction works as well as vehicle movements and warning signs etc. .needs to be prepared and implemented.

#### B) Environmental Management Plan

##### I. Air Quality

Possible impacts during construction are dust emission due to activities such as excavation, leveling, movement of vehicles at construction site. Emission due to operation of construction machineries.

**Following mitigation measures should be adopted by the contractors;**

- 1) Construction materials shall be transported to the site in covered trucks, where necessary.
- 2) Land clearing for construction site will be kept at the absolute minimum practicable.
- 3) Layout should be designed to minimize the removal of soil and vegetation

- 4) Topsoil removed will be preserved for later reinstatement purposes by piling it within and along the boundary of the site.
- 5) Dust suppression systems (water spray) shall be put into service as per requirement at the construction site.
- 6) Fuel used for machineries shall be clean and with low Sulphur content.
- 7) Construction machineries used shall have a valid PUC certificate.
- 8) Construction workers shall be provided with clean fuel for cooking.
- 9) Reducing speed of vehicle on Water Bound Macadam (WBM) road within the construction site to 20 km/hr will reduce dust emission.
- 10) Vehicles used shall be Bharat Stage V or VI compliant as per the prevailing regulations.

## **II. Noise quality**

Noise quality shall be impacted due to operation of construction machineries. Mitigation measures should be adopted are as follows;

- 1) Provision of silencers to modulate the noise generated by machines
- 2) Provision of protective devices like ear muff/ plugs to the workers who will be working in the noise prone areas.
- 3) Acoustic enclosure to D.G set shall be provided if used.
- 4) Construction activity generating noise shall be limited to the day time

## **III. Water Use and Quality**

Following water conservation measures should be adopted;

- 1) Curing water shall be sprayed on to the concrete structures instead of free flow of water.
- 2) Concrete structures shall be covered with thick cloth/gunny bags to avoid water rebound and will ensure sustained and complete curing.
- 3) Following mitigation measures should be integrated in case of waste water generated from temporary labour tents or rainwater run-off from construction sites;
- 4) Sewage generated shall be treated in septic tank followed by soak pits.
- 5) Silt traps shall be provided prior to discharge of run-off from construction area into drains.
- 6) An oil trap shall be provided in the drainage line to prevent contamination by accidental spillage of oil and grease.
- 7) Washdown area shall be provided for cleaning of vehicle wheels and the waste water shall be drained properly. Here also a settling pit and baffled oil water separator shall be provided.

## **IV. Soil Quality**

Possible impacts on Soil Quality are due to generation of construction waste and municipal solid waste from workers camps.

**Following mitigation measures should be followed;**

- 1) Construction waste generated shall be collected, segregated and disposed as per the Construction and Demolition Waste Rules 2016.

- 2) Municipal solid waste generated shall be disposed as per Solid Waste Management Rules 2016.
- 3) Used oil generated shall be collected and sold to authorized recyclers.

**V. Design Elements for energy efficiency:**

General measures that shall be adopted in the design for energy efficient and sustainable design of building for Warehouse, Cold Storages, etc. are as follows;

- 1) Building design shall utilize maximum natural daylight and rely minimum on artificial lighting.
- 2) Use low energy Light Emitting Diode (LED) lighting system to reduce their energy usage.
- 3) Waste management based on the concept of reduce, reuse and recycle shall be adopted to promote waste avoidance ahead of recycling and disposal.
- 4) Electrical / electronic equipment used in the facility shall be of 3 star and above rating.
- 5) Warehouse and Retails shall utilize solar energy for internal and external lighting to the extent possible.
- 6) Construction material to the extent possible shall be sourced locally to reduce carbon foot print.
- 7) Building material to the extent possible considering the design requirement shall utilize recyclable material such as fly ash bricks.
- 8) Refrigerator trucks shall be energy efficient and Bharat Stage VI and above compliant as per the prevailing norms.
- 9) Cold Storages and Retails shall use refrigerants that are environment friendly and non-ozone depleting and adhere to Ozone Depleting Substances (Regulation and Control) Rules, 2000 and its amendments.
- 10) HVAC (Heat Ventilation and Air Conditioning) system used shall be energy efficient.

**Performance Security - Bank Guarantee**

*[Guarantor letterhead or SWIFT identifier code]*

Performance Guarantee No.....*[insert guarantee reference number]*

Date.....*[insert date of issue of the guarantee]*

To:

WHEREAS (hereinafter called "the Contractor") has undertaken, in pursuance of Contract No. \_\_\_\_ dated \_\_\_\_\_ to execute RFB for Construction of *[name of Contract and brief description of Works]* (hereinafter called "the Contract");

AND WHEREAS it has been stipulated by you in the said Contract that the Contractor shall furnish you with a Bank Guarantee by a recognized bank for the sum specified therein as security for compliance with his obligations in accordance with the Contract;

AND WHEREAS we have agreed to give the Contractor such a Bank Guarantee;

NOW THEREFORE we hereby affirm that we are the Guarantor and responsible to you, on behalf of the Contractor, up to a total of \_\_\_\_\_ *[amount of guarantee<sup>2</sup>]* \_\_\_\_\_ *[in words]*, such sum being payable in the types and proportions of currencies in which the Contract Price is payable, and we undertake to pay you, upon your first written demand and without cavil or argument, any sum or sums within the limits of \_\_\_\_\_ *[amount of guarantee]* as aforesaid without your needing to prove or to show grounds or reasons for your demand for the sum specified therein.

We hereby waive the necessity of your demanding the said debt from the Contractor before presenting us with the demand.

We further agree that no change or addition to or other modification of the terms of the Contract or of the Works to be performed thereunder or of any of the Contract documents which may be made between you and the Contractor shall in any way release us from any liability under this guarantee, and we hereby waive notice of any such change, addition or modification.

This guarantee shall be valid until ..... (i.e.) 28 days after the date of issue of the Certificate of Completion, and any demand for payment under it must be received by us at this office on or before that date.

Signature and seal of the guarantor \_\_\_\_\_

Name of Bank \_\_\_\_\_

Address \_\_\_\_\_

Date \_\_\_\_\_

*Note: All italicized text (including footnotes) is for use in preparing this form and shall be deleted from the final product.*

<sup>2</sup>An amount shall be inserted by the Guarantor, representing the percentage of the Contract Price specified in the Contract and denominated in Indian Rupees.

**Section C. Fraud and Corruption**  
*(Text in this Section shall not be modified)*

**1. Purpose**

1.1 The Bank's Anti-Corruption Guidelines and this annex apply with respect to procurement under Bank Investment Project Financing operations.

**2. Requirements**

2.1 The Bank requires that Borrowers (including beneficiaries of Bank financing); bidders (applicants/proposers), consultants, contractors and suppliers; any sub-contractors, sub-consultants, service providers or suppliers; any agents (whether declared or not); and any of their personnel, observe the highest standard of ethics during the procurement process, selection and contract execution of Bank-financed contracts, and refrain from Fraud and Corruption.

2.2 To this end, the Bank:

- a. Defines, for the purposes of this provision, the terms set forth below as follows:
  - i. "corrupt practice" is the offering, giving, receiving, or soliciting, directly or indirectly, of anything of value to influence improperly the actions of another party;
  - ii. "fraudulent practice" is any act or omission, including misrepresentation, that knowingly or recklessly misleads, or attempts to mislead, a party to obtain financial or other benefit or to avoid an obligation;
  - iii. "collusive practice" is an arrangement between two or more parties designed to achieve an improper purpose, including to influence improperly the actions of another party;
  - iv. "coercive practice" is impairing or harming, or threatening to impair or harm, directly or indirectly, any party or the property of the party to influence improperly the actions of a party;
  - v. "obstructive practice" is:
    - (a) deliberately destroying, falsifying, altering, or concealing of evidence material to the investigation or making false statements to investigators in order to materially impede a Bank investigation into allegations of a corrupt, fraudulent, coercive, or collusive practice; and/or threatening, harassing, or intimidating any party to prevent it from disclosing its knowledge of matters relevant to the investigation or from pursuing the investigation; or
    - (b) acts intended to materially impede the exercise of the Bank's inspection and audit rights provided for under paragraph 2.2 e. below.
- b. Rejects a proposal for award if the Bank determines that the firm or individual recommended for award, any of its personnel, or its agents, or its sub-consultants, sub-contractors, service providers, suppliers and/ or their employees, has, directly or indirectly, engaged in corrupt, fraudulent, collusive, coercive, or obstructive practices in competing for the contract in question;
- c. In addition to the legal remedies set out in the relevant Legal Agreement, may take other appropriate actions, including declaring misprocurement, if the Bank

determines at any time that representatives of the Borrower or of a recipient of any part of the proceeds of the loan engaged in corrupt, fraudulent, collusive, coercive, or obstructive practices during the procurement process, selection and/or execution of the contract in question, without the Borrower having taken timely and appropriate action satisfactory to the Bank to address such practices when they occur, including by failing to inform the Bank in a timely manner at the time they knew of the practices;

- d. Pursuant to the Bank's Anti- Corruption Guidelines and in accordance with the Bank's prevailing sanctions policies and procedures, may sanction a firm or individual, either indefinitely or for a stated period of time, including by publicly declaring such firm or individual ineligible (i) to be awarded or otherwise benefit from a Bank-financed contract, financially or in any other manner;<sup>3</sup> (ii) to be a nominated<sup>4</sup> sub-contractor, consultant, manufacturer or supplier, or service provider of an otherwise eligible firm being awarded a Bank-financed contract; and (iii) to receive the proceeds of any loan made by the Bank or otherwise to participate further in the preparation or implementation of any Bank-financed project;
- e. Requires that a clause be included in bidding/request for proposals documents and in contracts financed by a Bank loan, requiring (i) bidders(applicants/proposers), consultants, contractors, and suppliers, and their sub-contractors, sub-consultants, service providers, suppliers, agents personnel, permit the Bank to inspect<sup>5</sup> all accounts, records and other documents relating to the procurement process, selection and/ or contract execution, and to have them audited by auditors appointed by the Bank

---

<sup>3</sup> For the avoidance of doubt, a sanctioned party's ineligibility to be awarded a contract shall include, without limitation, (i) applying for pre-qualification, expressing interest in a consultancy, and bidding, either directly or as a nominated sub-contractor, nominated consultant, nominated manufacturer or supplier, or nominated service provider, in respect of such contract, and (ii) entering into an addendum or amendment introducing a material modification to any existing contract.

<sup>4</sup> A nominated sub-contractor, nominated consultant, nominated manufacturer or supplier, or nominated service provider (different names are used depending on the particular bidding document) is one which has been: (i) included by the bidder in its pre-qualification application or bid because it brings specific and critical experience and know-how that allow the bidder to meet the qualification requirements for the particular bid; or (ii) appointed by the Borrower.

<sup>5</sup> Inspections in this context usually are investigative (i.e., forensic) in nature. They involve fact-finding activities undertaken by the Bank or persons appointed by the Bank to address specific matters related to investigations/audits, such as evaluating the veracity of an allegation of possible Fraud and Corruption, through the appropriate mechanisms. Such activity includes but is not limited to: accessing and examining a firm's or individual's financial records and information, and making copies thereof as relevant; accessing and examining any other documents, data and information (whether in hard copy or electronic format) deemed relevant for the investigation/audit, and making copies thereof as relevant; interviewing staff and other relevant individuals; performing physical inspections and site visits; and obtaining third party verification of information.

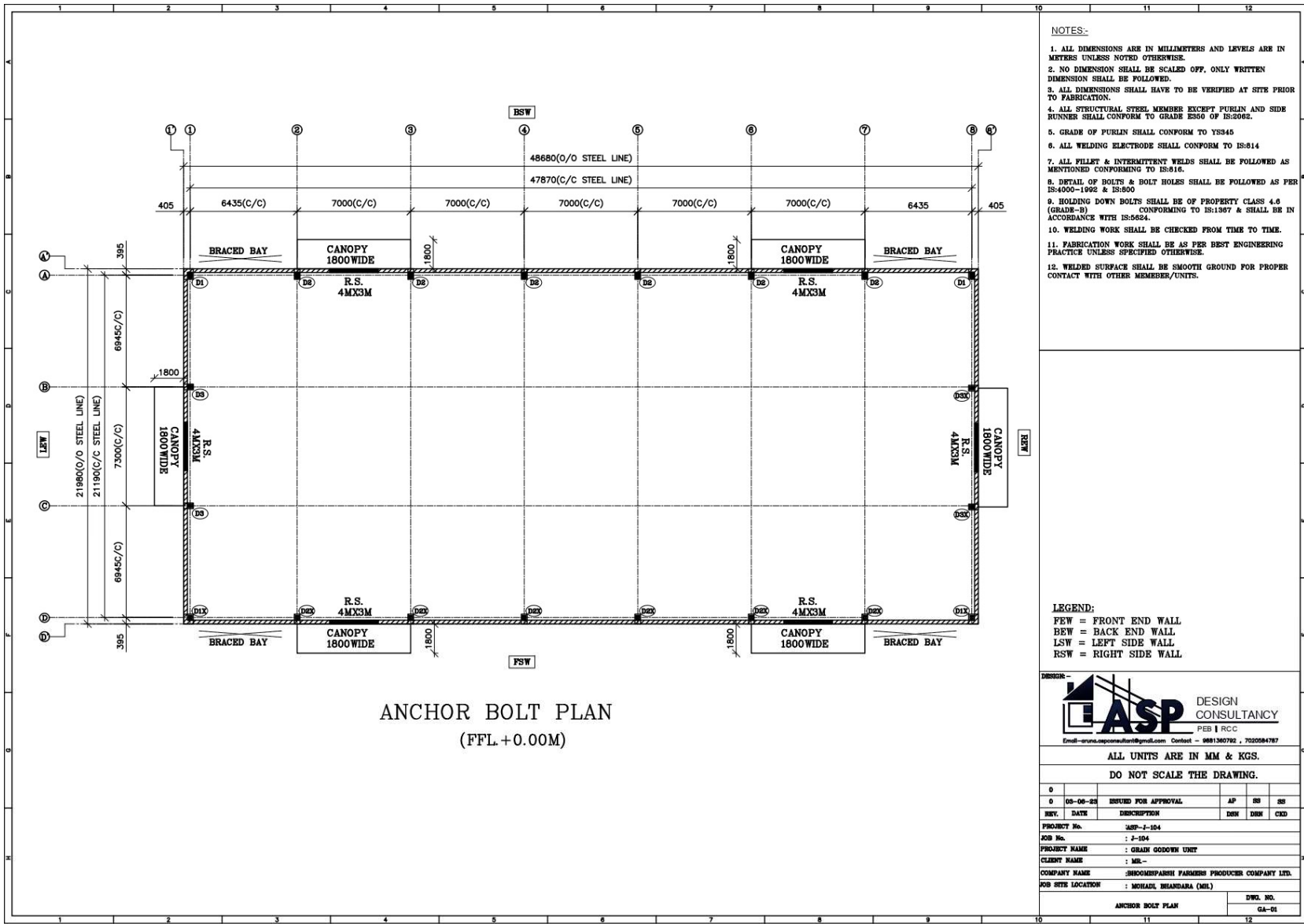

ANCHOR BOLT PLAN  
(FFL +0.00M)

- NOTES:-
1. ALL DIMENSIONS ARE IN MILLIMETERS AND LEVELS ARE IN METRES UNLESS NOTED OTHERWISE.
  2. NO DIMENSION SHALL BE SCALED OFF, ONLY WRITTEN DIMENSION SHALL BE FOLLOWED.
  3. ALL DIMENSIONS SHALL HAVE TO BE VERIFIED AT SITE PRIOR TO FABRICATION.
  4. ALL STRUCTURAL STEEL MEMBER EXCEPT PURLIN AND SIDE RUNNER SHALL CONFORM TO GRADE E350 OF IS:2062.
  5. GRADE OF PURLIN SHALL CONFORM TO YS45
  6. ALL WELDING ELECTRODE SHALL CONFORM TO IS-814
  7. ALL FILLET & INTERMITTENT WELDS SHALL BE FOLLOWED AS MENTIONED CONFORMING TO IS-816.
  8. DETAIL OF BOLTS & BOLT HOLES SHALL BE FOLLOWED AS PER IS:4000-1992 & IS:800
  9. HOLDING DOWN BOLTS SHALL BE OF PROPERTY CLASS 4.6 (GRADE-B) CONFORMING TO IS:1587 & SHALL BE IN ACCORDANCE WITH IS:5624.
  10. WELDING WORK SHALL BE CHECKED FROM TIME TO TIME.
  11. FABRICATION WORK SHALL BE AS PER BEST ENGINEERING PRACTICE UNLESS SPECIFIED OTHERWISE.
  12. WELDED SURFACE SHALL BE SMOOTH GROUND FOR PROPER CONTACT WITH OTHER MEMBER/UNITS.

- LEGEND:
- FEW = FRONT END WALL
  - BEW = BACK END WALL
  - LSW = LEFT SIDE WALL
  - RSW = RIGHT SIDE WALL

DESIGN -

DESIGN CONSULTANCY  
PEB | RCC  
Email - [asp.consultancy@gmail.com](mailto:asp.consultancy@gmail.com) Contact - 9881360792 , 7520564787

ALL UNITS ARE IN MM & KGS.  
DO NOT SCALE THE DRAWING.

0	02-08-22	ISSUED FOR APPROVAL	AP	RS	CS
REV.	DATE	DESCRIPTION	DES	DES	CKD
PROJECT No.	ASP-J-104				
JOB No.	: J-104				
PROJECT NAME	: GRAM GODOWN UNIT				
CLIENT NAME	: MR-				
COMPANY NAME	: SHIKHARPURI FARMERS PRODUCER COMPANY LTD.				
JOB SITE LOCATION	: MICHAEL BHANDARA (MIL)				
ANCHOR BOLT PLAN				DWC. NO. GA-01	

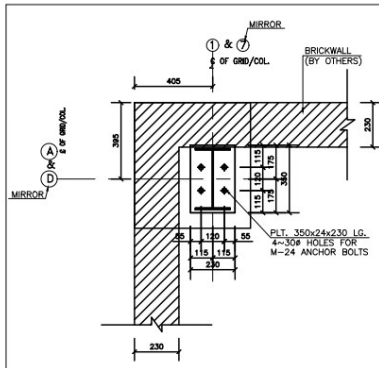

DETAIL **D1** (AS DRAWN)  
(2 No. REQD.) GA-01  
DETAIL **D1X** (OPP. HAND)  
(2 No. REQD.) GA-01

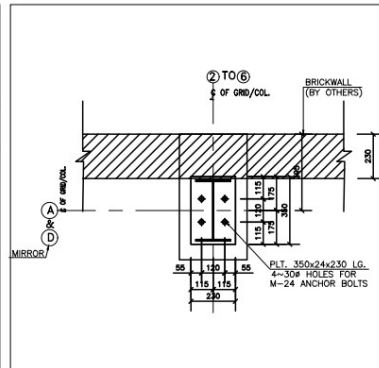

DETAIL **D2** (AS DRAWN)  
(6 No. REQD.) GA-01  
DETAIL **D2X** (OPP. HAND)  
(6 No. REQD.) GA-01

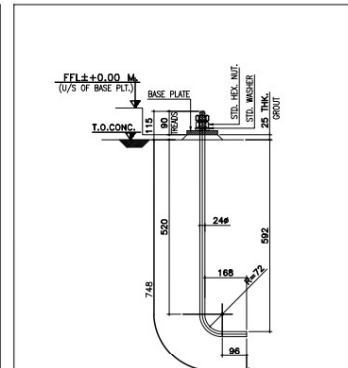

M-24 ANCHOR BOLT DETAIL  
(56 Nos. REQD.)

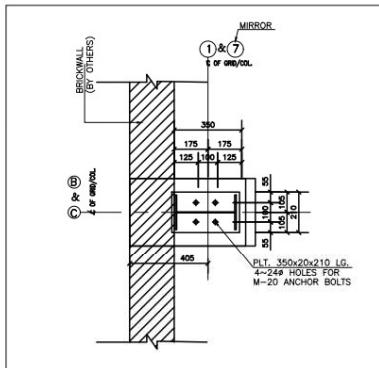

DETAIL **D3** (AS DRAWN)  
(2 No. REQD.) GA-01  
DETAIL **D3X** (OPP. HAND)  
(2 No. REQD.) GA-01

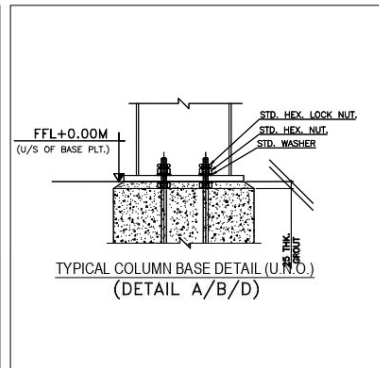

TYPICAL COLUMN BASE DETAIL (U.N.O.)  
(DETAIL A/B/D)

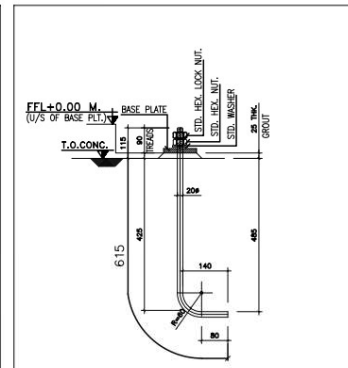

M-20 ANCHOR BOLT DETAIL  
(16 Nos. REQD.)

## ANCHOR BOLT DETAIL PLAN

DESIGN -



**ASP** DESIGN CONSULTANCY  
PEB | RCC  
Email - [aruna.aspcounselant@gmail.com](mailto:aruna.aspcounselant@gmail.com) Contact - 9851360792, 7020584787

ALL UNITS ARE IN MM & KGS.

DO NOT SCALE THE DRAWING.

0				
0	03-06-23	ISSUED FOR APPROVAL	AP	SS
REV.	DATE	DESCRIPTION	DSN	DRN

PROJECT No.	ASP-J-104			
JOB No.	: J-104			
PROJECT NAME	: GRAM GODOWN UNIT			
CLIENT NAME	: MR-			
COMPANY NAME	: BHOOMISPARSH FARMERS PRODUCER COMPANY LTD.			
JOB SITE LOCATION	: MOHADL BHANDARA (MH.)			

ANCHOR BOLT PLAN	DWG. NO. GA-01
------------------	-------------------

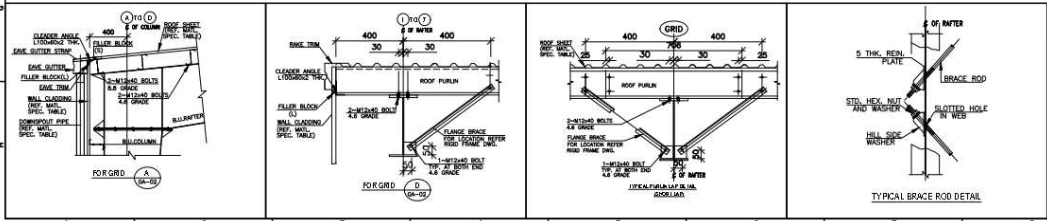
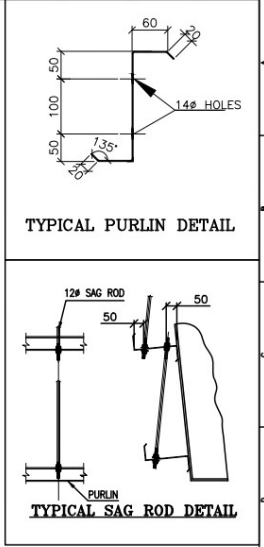
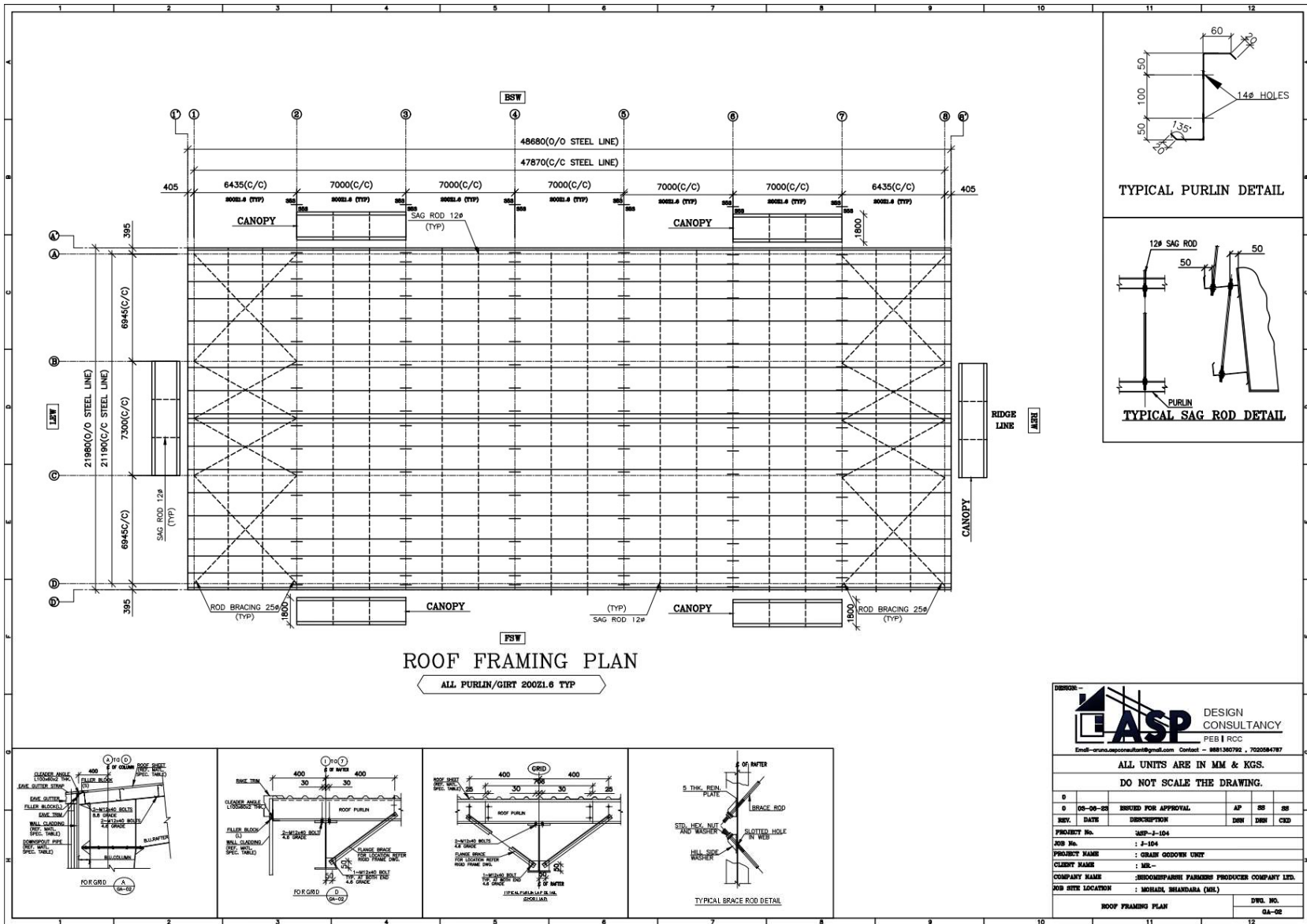

**DESIGNER**  
**ASP** DESIGN CONSULTANCY  
PEB | RCC  
Email - [crun.asspcan@rediffmail.com](mailto:crun.asspcan@rediffmail.com) Contact - 8881360792, 7020584787

**ALL UNITS ARE IN MM & KGS.**  
**DO NOT SCALE THE DRAWING.**

REV.	DATE	DESCRIPTION	DRN	DSN	CRD
0	08-08-23	ISSUED FOR APPROVAL	AP	SS	SS

PROJECT No. : ASP-2-104  
 JOB No. : 2-104  
 PROJECT NAME : GRASS GODOWN UNIT  
 CLIENT NAME : M.S.  
 COMPANY NAME : BHODGHPARME FARMERS PRODUCER COMPANY LTD.  
 JOB SITE LOCATION : MORAD, BHANDARA (MH)

**ROOF FRAMING PLAN**  
 DWG. NO. : QA-02

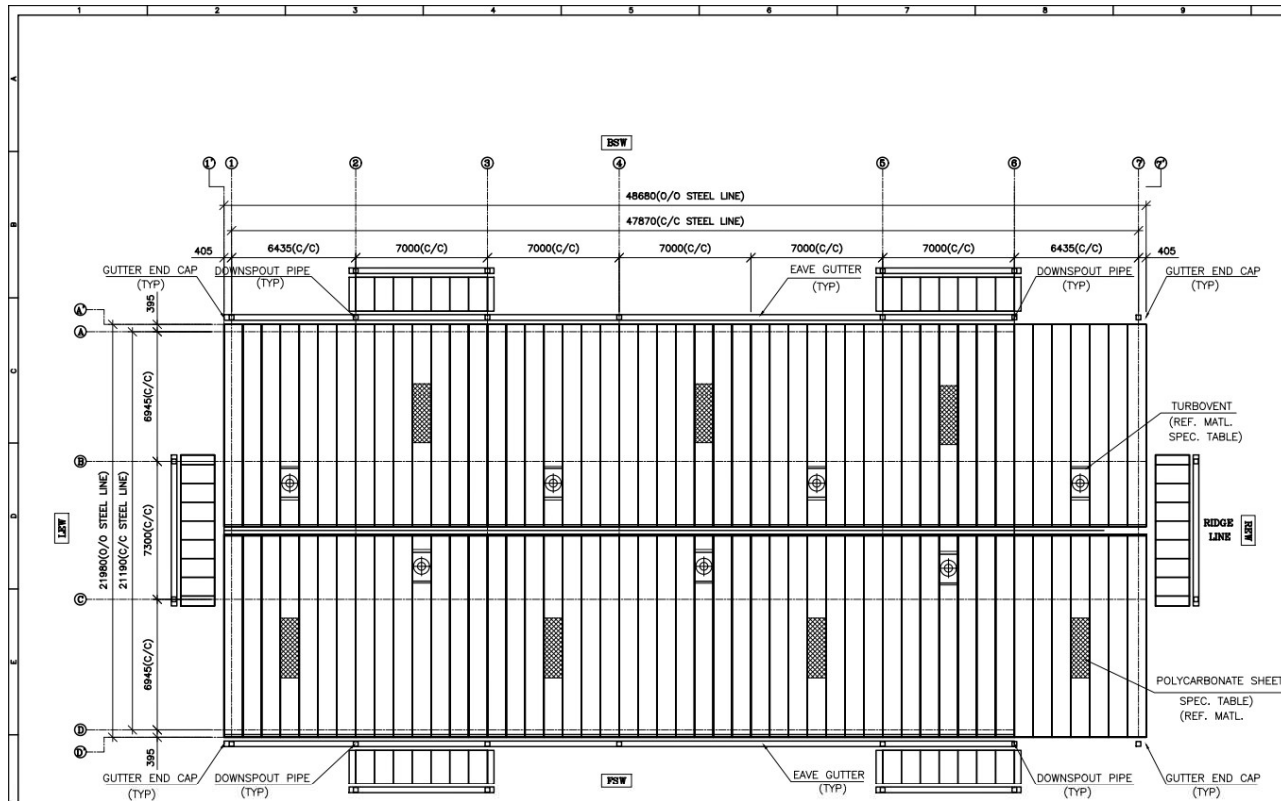

ROOF SHEETING PLAN

MATERIAL SPECIFICATION		
ITEM	DESCRIPTION	REMARK
ROOF SHEET	MATERIAL = BQ LCPL 1012 THICKNESS = 0.5MM COLOUR = BARE GALVALUME	
WALL CLADDING & CANOPY PANEL	MATERIAL = LCPL 1012 THICKNESS = 0.5MM COLOUR = TO BE CONFIRM	
EAVES GUTTER	THICKNESS = 0.5MM MATERIAL = GALVALUME COLOUR = TO BE CONFIRM	
DOWN SPOUT	TYPE = SQ. 110 BOX COLOUR = TO BE CONFIRM	(AT EVERY GRID)
SKYLIGHT	TYPE = POLYCARBONATE SHEET THICKNESS = 2.0 MM SIZE = 1012x3200 LG.	6 NOS.
TURBO VENTILATOR	SIZE = 600MM DIA.	6 NOS.

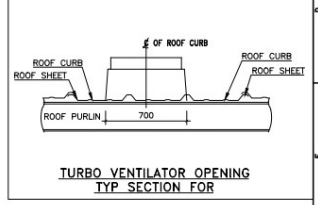
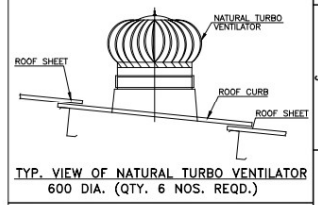

**LEGEND:**  
 FEW = FRONT END WALL  
 BEW = BACK END WALL  
 LSW = LEFT SIDE WALL  
 RSW = RIGHT SIDE WALL

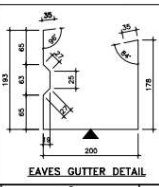
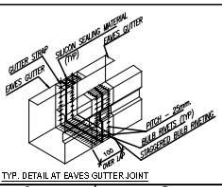
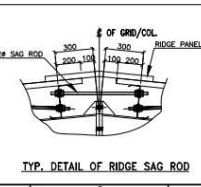
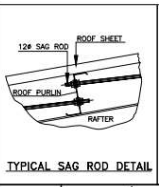
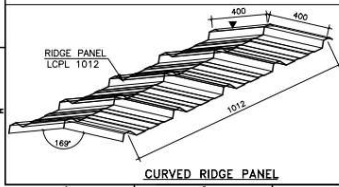

**ASP** DESIGN CONSULTANCY  
 FEB 1 RCC  
 Email - [www.aspconsultancy@gmail.com](mailto:www.aspconsultancy@gmail.com) Contact - 9881380792, 7022984787

ALL UNITS ARE IN MM & KGS.  
 DO NOT SCALE THE DRAWING.

0	08-08-23	ISSUED FOR APPROVAL	AP	RS	RS
REV.	DATE	DESCRIPTION	ISSN	ISSN	ISSN
PROJECT No. : ASP-J-104					
JOB No. : J-104					
PROJECT NAME : ORAIN GODOWN UNIT					
CLIENT NAME : 125					
COMPANY NAME : JINDOORPANSI FARMERS PRODUCER COMPANY LTD.					
JOB SITE LOCATION : MISHAL, BHANDARA (MH)					
ROOF SHEETING PLAN					DWG. NO. : CA-03

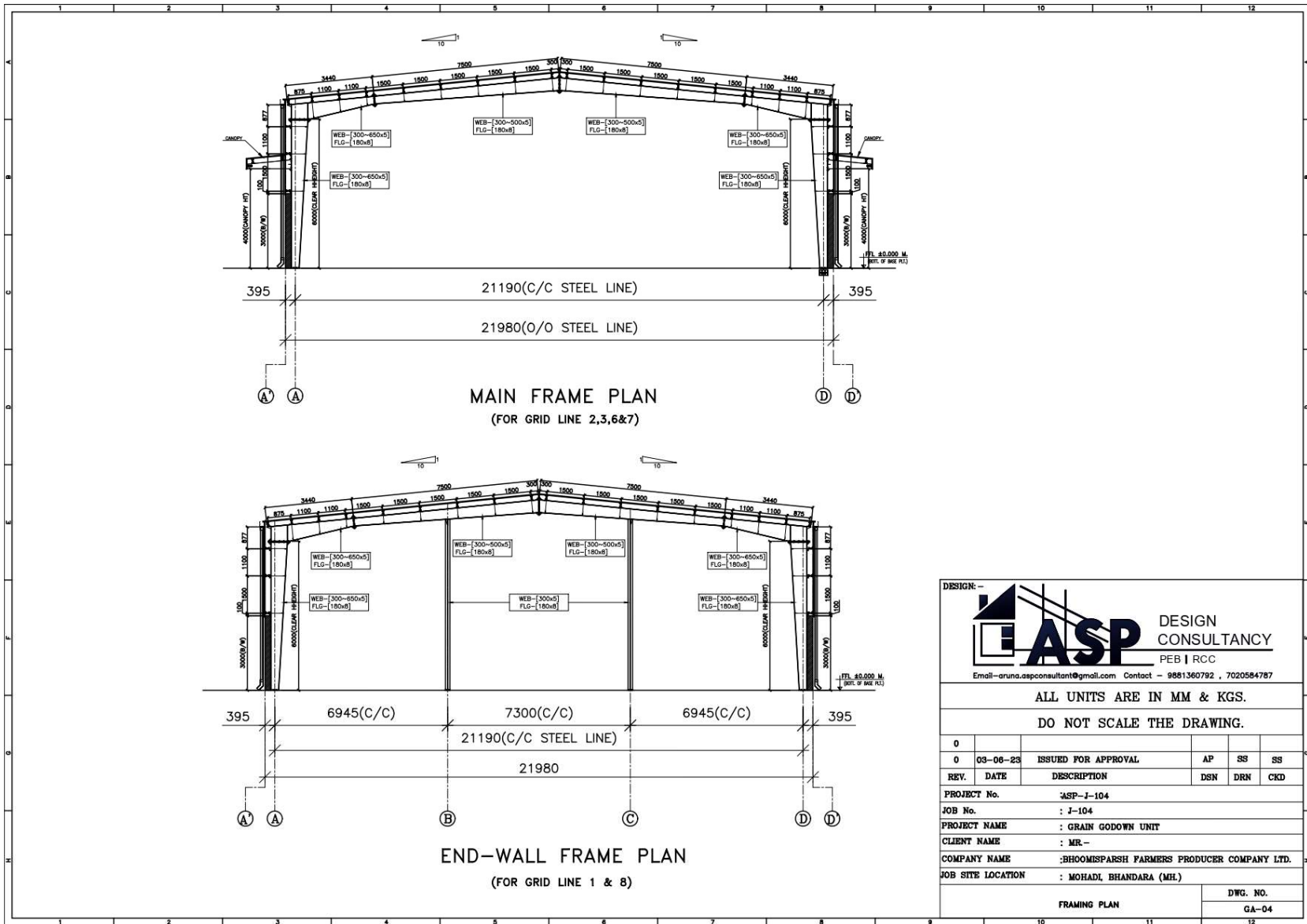

DESIGN:-



**ASP** DESIGN CONSULTANCY  
PEB | RCC  
Email:-aruna.aspc consultant@gmail.com Contact - 9881360792 , 7020584787

ALL UNITS ARE IN MM & KGS.

DO NOT SCALE THE DRAWING.

0	03-06-23	ISSUED FOR APPROVAL	AP	SS	SS
REV.	DATE	DESCRIPTION	DSN	DRN	CKD

PROJECT No. : ASP-J-104  
 JOB No. : J-104  
 PROJECT NAME : GRAIN GODOWN UNIT  
 CLIENT NAME : MR.-  
 COMPANY NAME : BHOOMISPARSH FARMERS PRODUCER COMPANY LTD.  
 JOB SITE LOCATION : MOHADI, BHANDARA (MH.)

FRAMING PLAN	DWG. NO.
	GA-04

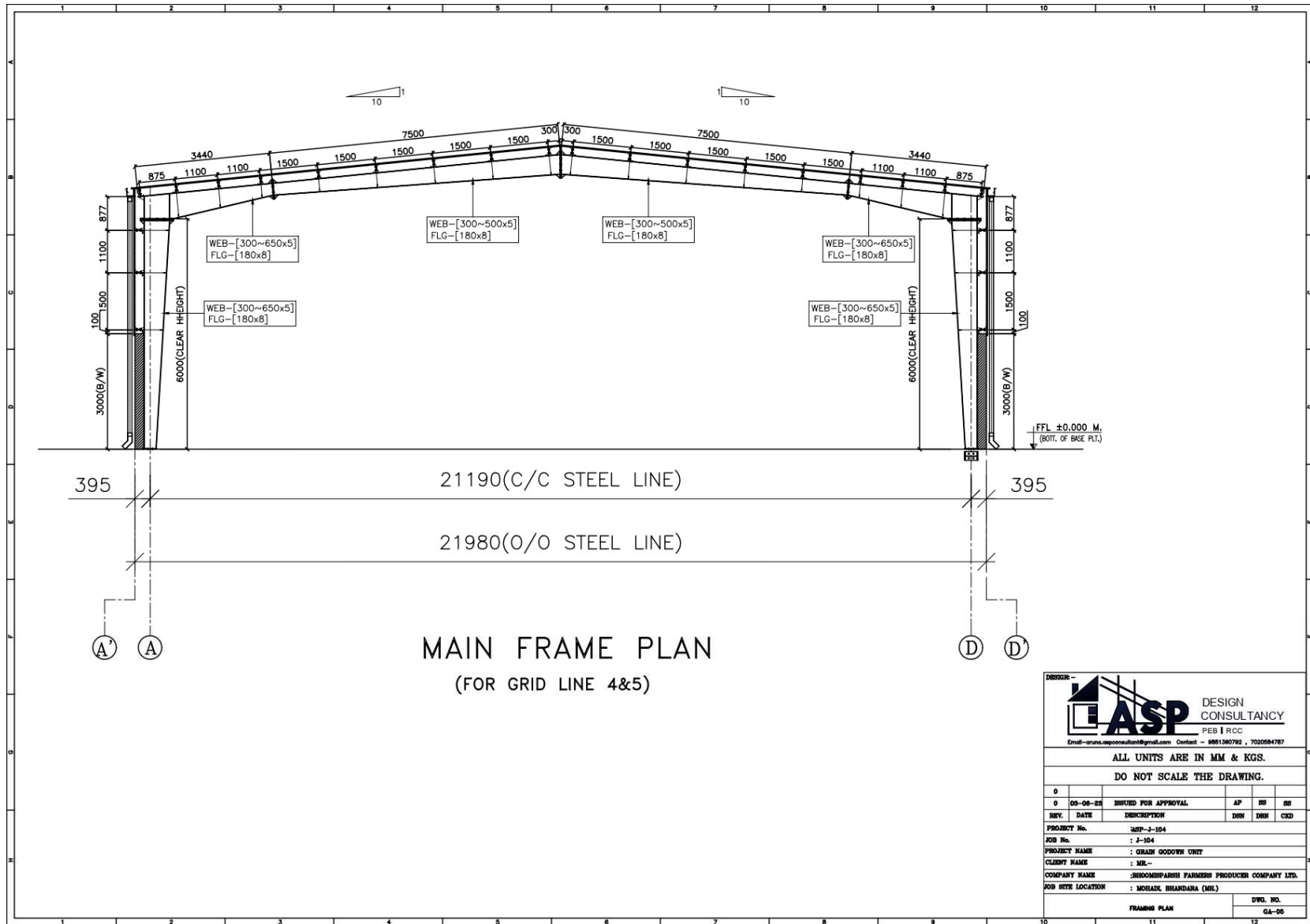

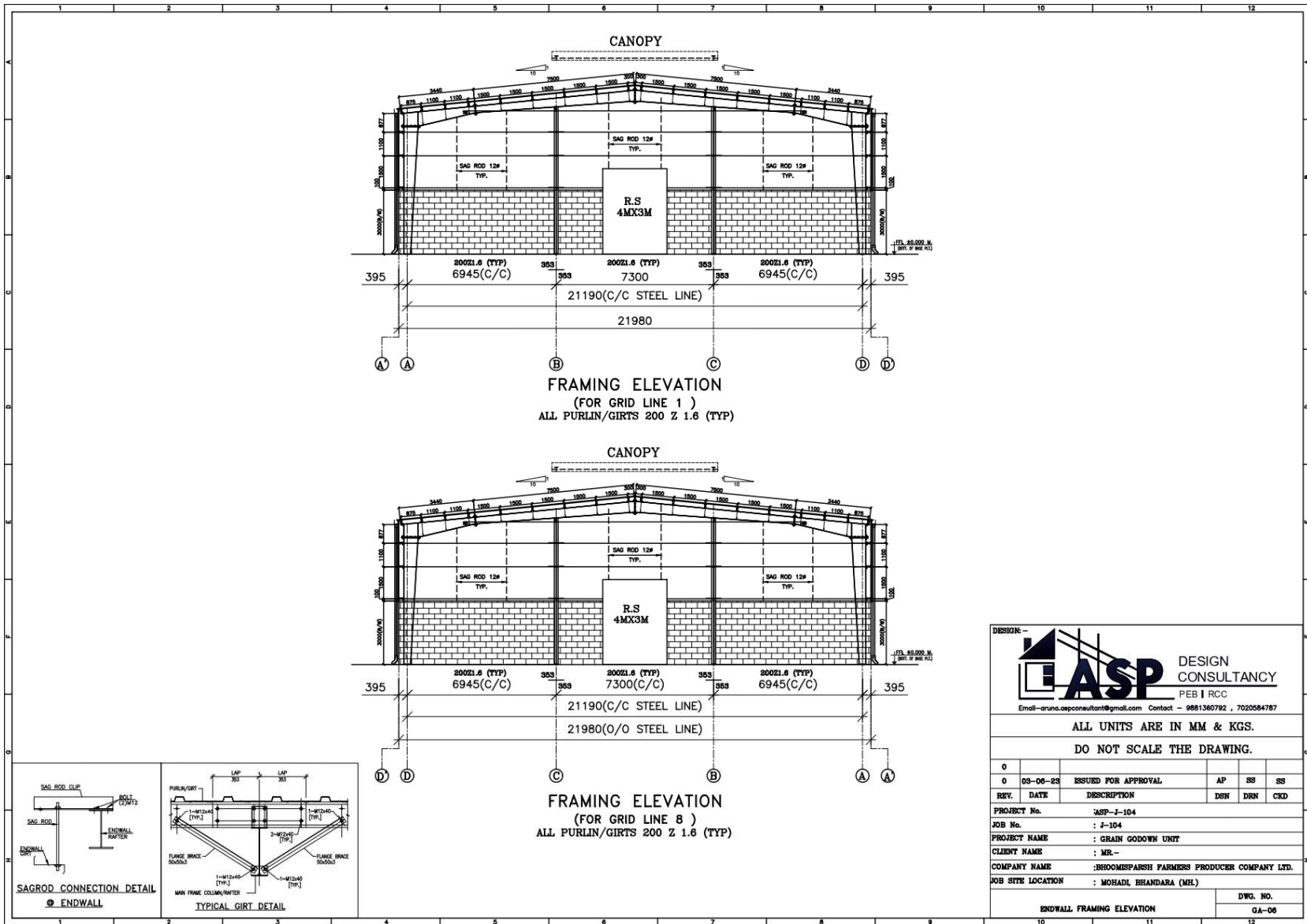

DESIGN -

**ASP** DESIGN CONSULTANCY  
PEB I RCC  
Email - aruna.aspconsultant@gmail.com Contact - 9881360792, 7020584787

ALL UNITS ARE IN MM & KGS.  
DO NOT SCALE THE DRAWING.

REV.	DATE	DESCRIPTION	DSN	DRN	CKD
0	03-06-23	ISSUED FOR APPROVAL	AP	SS	SS

PROJECT No. : ASP-1-104  
JOB No. : J-104  
PROJECT NAME : GRAIN GODOWN UNIT  
CLIENT NAME : MR.-  
COMPANY NAME : BHOOMIPARSH FARMERS' PRODUCER COMPANY LTD.  
JOB SITE LOCATION : MOHADLI, BHANDARA (MH.)

ENDWALL FRAMING ELEVATION	DWG. NO. GA-06
---------------------------	-------------------

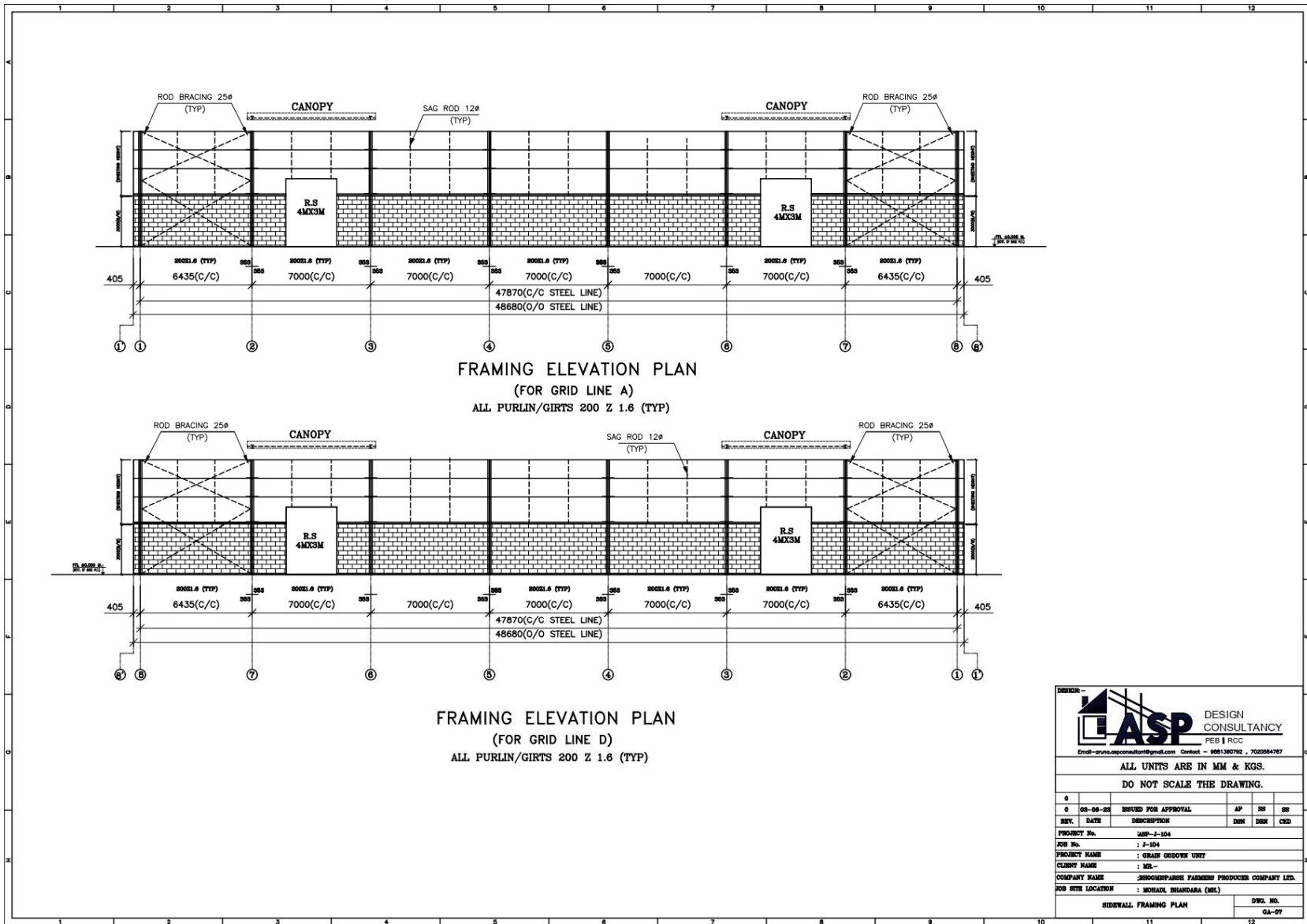

**DESIGN -**

**ALL UNITS ARE IN MM & KGS.**

**DO NOT SCALE THE DRAWING.**

REV.	DATE	DESCRIPTION	DES	CHK	CRD
0	05-08-22	ISSUED FOR APPROVAL	AP	SS	SS

**PROJECT No.** : MSP-2-104  
**JOB No.** : F-104  
**PROJECT NAME** : GRASS GARDEN UNIT  
**CLIENT NAME** : M.S.  
**COMPANY NAME** : SHODHANPARKI FARMERS PRODUCER COMPANY LTD.  
**JOB SITE LOCATION** : MORADI, BHANDARA (MH)

<b>SIDEWALL FRAMING PLAN</b>	<b>DRG. NO.</b>
	QA-07

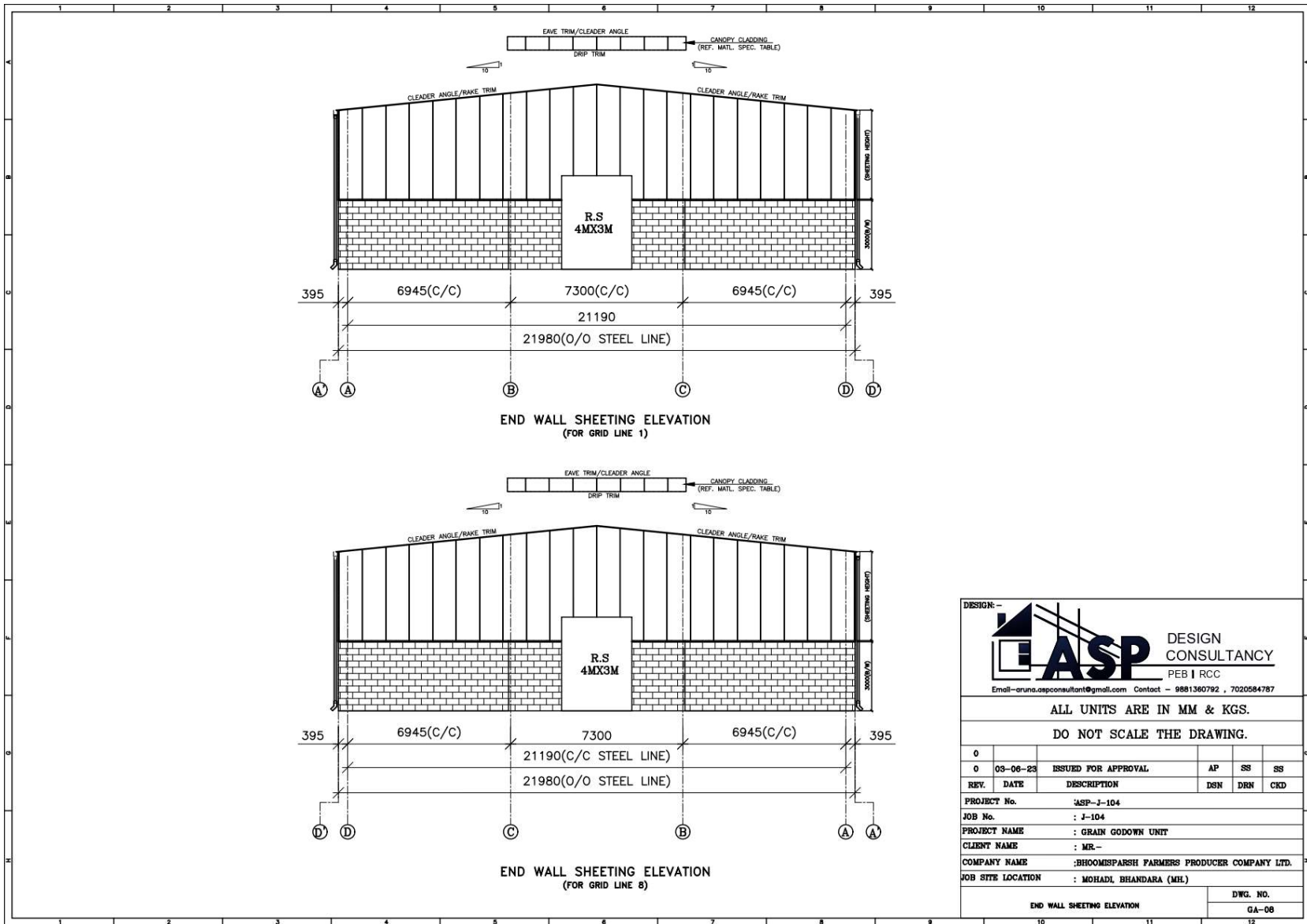

DESIGN: -



**ASP** DESIGN CONSULTANCY  
PEB I RCC  
Email - aruna.aspc consultant@gmail.com Contact - 981360792 , 7020584787

ALL UNITS ARE IN MM & KGS.  
DO NOT SCALE THE DRAWING.

0					
0	03-06-23	ISSUED FOR APPROVAL	AP	SS	SS
REV.	DATE	DESCRIPTION	DSN	DRN	CKD
PROJECT No.		ASP-J-104			
JOB No.		: J-104			
PROJECT NAME		: GRAIN GODOWN UNIT			
CLIENT NAME		: MR.-			
COMPANY NAME		: BHOMISPARSH FARMERS PRODUCER COMPANY LTD.			
JOB SITE LOCATION		: MOHADL BHANDARA (MH.)			
END WALL SHEETING ELEVATION			DWG. NO.		
			GA-08		

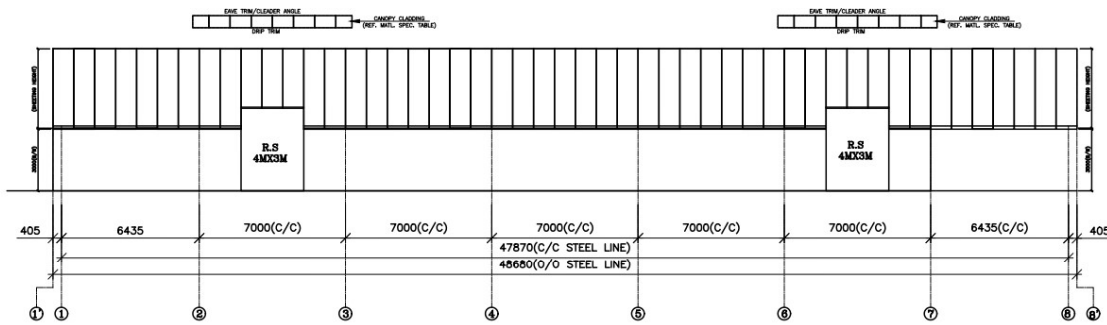

SHEETING ELEVATION PLAN  
(FOR GRID LINE A)

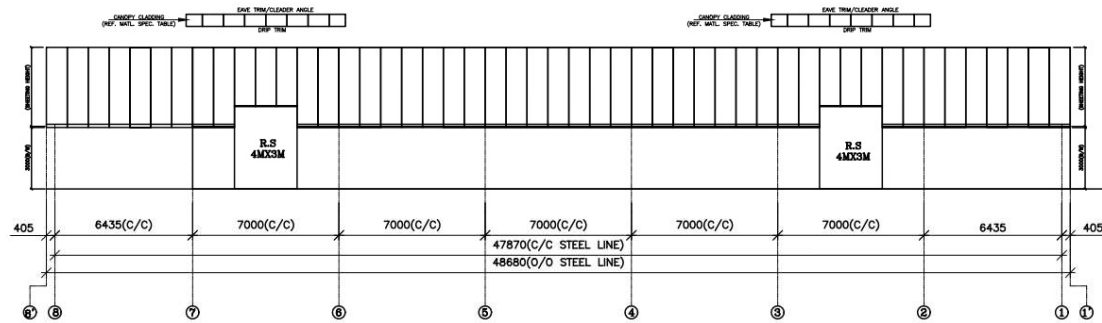

SHEETING ELEVATION PLAN  
(FOR GRID LINE D)

DESIGNER -

**ASP** DESIGN CONSULTANCY  
PEB I RCC  
Email - [asp.consultant@gmail.com](mailto:asp.consultant@gmail.com) Contact - 9881360792, 7020584787

ALL UNITS ARE IN MM & KGS.  
DO NOT SCALE THE DRAWING.

REV.	DATE	DESCRIPTION	DGN	DRN	CKD
0	03-06-25	ISSUED FOR APPROVAL	AP	SS	SS

PROJECT No. : ASP-J-104  
JOB No. : J-104  
PROJECT NAME : GRAIN GODOWN UNIT  
CLIENT NAME : MRL-  
COMPANY NAME : BECOMEPARSHI FARMERS PRODUCER COMPANY LTD.  
JOB SITE LOCATION : MOHADI, BHANDARA (MH)

SIDEWALL SHEETING ELEVATION PLAN	DWG. NO. 0a-08
----------------------------------	-------------------